

## Operating instructions

Wine storage cabinet

Read the operating instructions before switching on for the first time

Page 10

EN

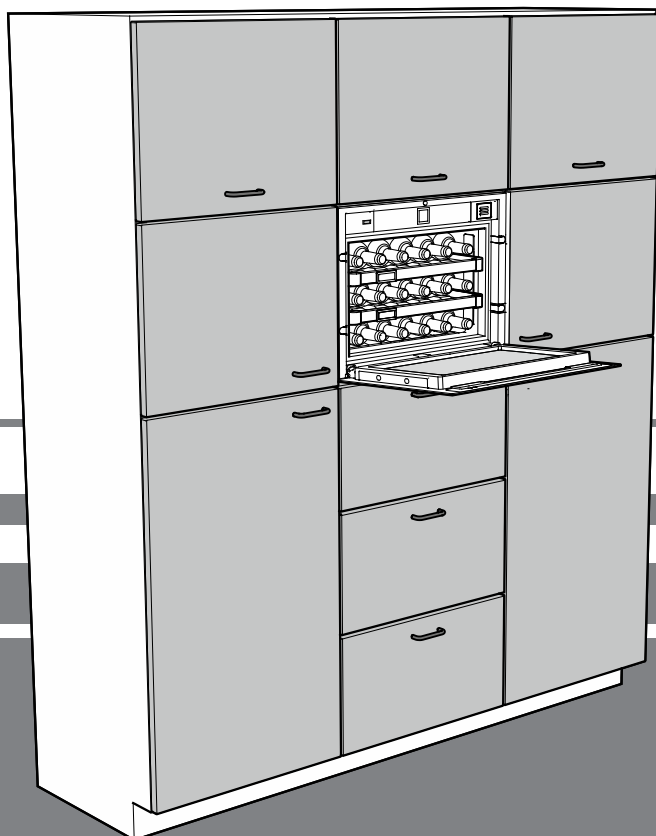

**7084 159-00**

WKEgb 582, WKEgw 582

**LIEBHERR**

## Content

Description of the appliance.....	10
Disposal notes.....	10
Safety instructions and warnings.....	11
Range of appliance use.....	11
Climate rating.....	12
Setting up.....	12
Electrical connection.....	12
Door opening mechanism (TipOpen).....	12
Operating and control elements.....	13
Switching the appliance on and off.....	13
Setting the temperature.....	13
Storing wine.....	14
Door open alarm.....	14
Temperature alarm.....	14
Fan.....	14
Child lock.....	14
Interior light.....	15
Storage diagram.....	15
Air exchange with activated charcoal filter.....	16
Cleaning.....	16
Malfunctions.....	17
Shutting your appliance down.....	17

## Disposal notes

The appliance contains reusable materials and should be disposed of properly - not simply with unsorted household refuse. Appliances which are no longer needed must be disposed of in a professional and appropriate way, in accordance with the current local regulations and laws.



When disposing of the appliance, ensure that the refrigerant circuit is not damaged to prevent uncontrolled escape of the refrigerant it contains (data on type plate) and oil.

- Disable the appliance.
- Pull out the mains plug.
- Cut through the connection cable.

### ⚠ WARNING

**Danger of suffocation due to packing material and plastic film!**

**Do not allow children to play with packaging material.**

**Take the packaging material to an official collection point.**

## Description of the appliance

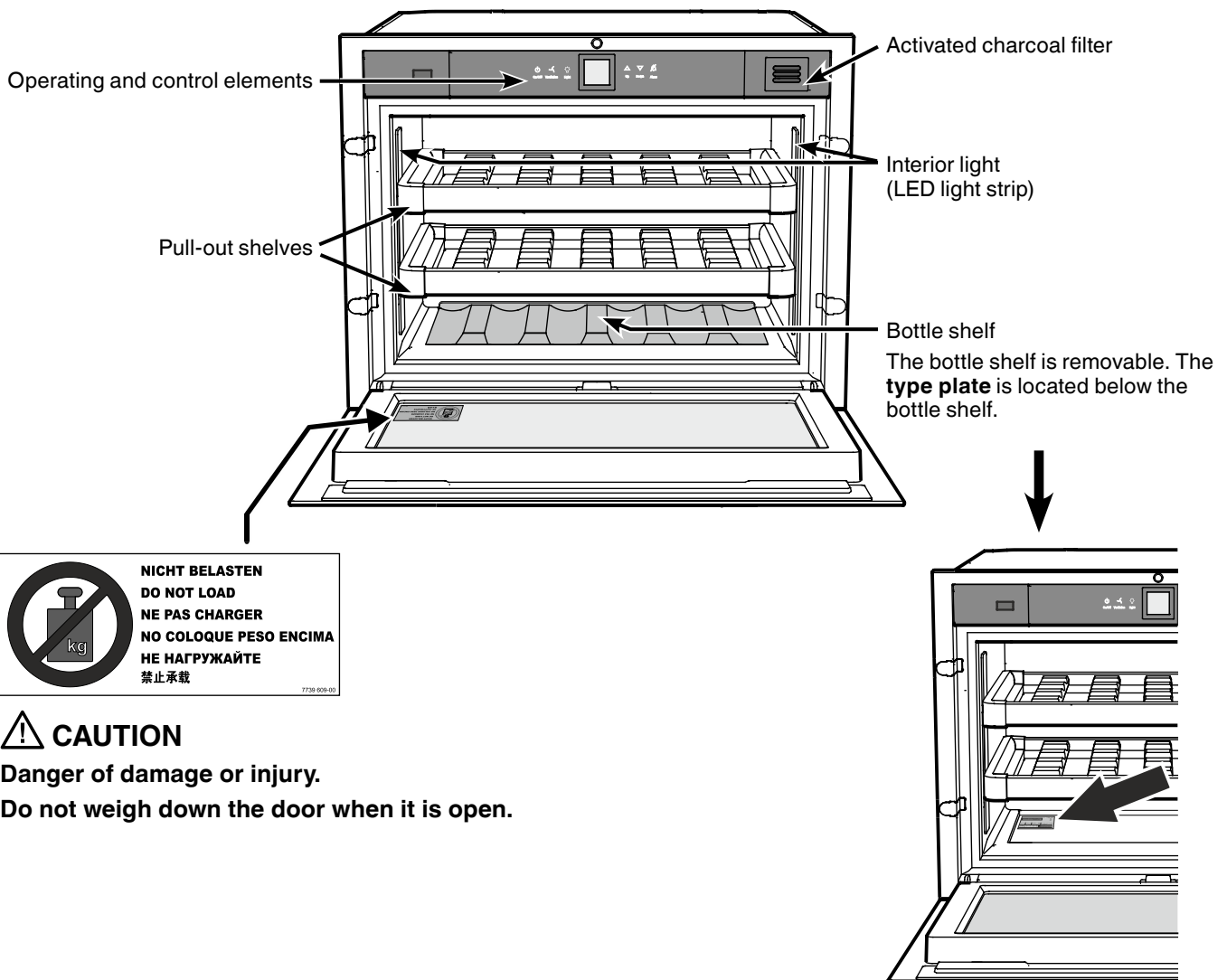

## Safety instructions and warnings

- To prevent injury or damage to the unit, the appliance should be unpacked and set up by two people.
- In the event that the appliance is damaged on delivery, contact the supplier immediately before connecting to the mains.
- To guarantee safe operation, ensure that the appliance is set up and connected as described in these operating instructions.
- Disconnect the appliance from the mains if any fault occurs. Pull out the plug, switch off or remove the fuse.
- When disconnecting the appliance, pull on the plug, not on the cable.
- Any repairs and work on the appliance should only be carried out by the customer service department, as unauthorised work could prove highly dangerous for the user. The same applies to changing the mains power cable.
- Do not allow naked flames or ignition sources to enter the appliance. When transporting and cleaning the appliance, ensure that the refrigerant circuit is not damaged. In the event of damage, make sure that there are no ignition sources nearby and keep the room well ventilated.
- Do not stand on the plinth, drawers or doors or use them to support anything else.
- This appliance can be used by children of 8 years old and over, and also by persons with restricted physical, sensory or mental capacity or lack of experience and knowledge, if they are supervised or have been instructed on safe use of the appliance and understand the resulting risks. Children must not be allowed to play with the appliance. Cleaning and user maintenance must not be carried out by children without supervision.
- Avoid prolonged skin contact with cold surfaces or chilled/frozen food. This could cause pain, numbness and frostbite. In the case of prolonged skin contact, protective measures should be taken, e.g. gloves should be worn.
- Do not consume food which has been stored for too long, as it could cause food poisoning.
- Do not store explosives or sprays using combustible propellants such as butane, propane, pentane, etc. in the appliance. Electrical components might cause leaking gas to ignite. You may identify such sprays by the printed contents or a flame symbol.
- Do not use electrical appliances inside the appliance.
- The appliance is designed for use in enclosed areas. Do not operate the appliance outdoors or in areas where it is exposed to splash water or damp conditions.
- The LED light strips illuminate the interior of the appliance. They are not suitable for lighting a room.
- When transporting or operating the appliance at an altitude of more than 1500 m above sea level, the glass pane in the door can break due to the reduction in air pressure. Broken fragments are sharp-edged and can cause serious injury.

### Range of appliance use

The appliance is suitable solely for storing wine in a domestic environment or similar. This includes, for example, use

- in staff kitchenettes, bed and breakfast establishments,
- by guests in cottages, hotels, motels and other forms of accommodation,
- in catering and similar services in the wholesale trade.

Use the appliance solely as is customary within a domestic environment. All other types of use are inadmissible.

The appliance is not suitable for storing and cooling medicines, blood plasma, laboratory preparations or similar substances and products covered by the 2007/47/EC Medical Devices Directive. Any misuse of the appliance may result in damage to or spoilage of stored goods.

Furthermore, the appliance is not suitable for operation in potentially explosive atmospheres.

## Climate rating

The climate rating indicates the room temperature at which the appliance may be operated in order to achieve full refrigeration performance.

The climate rating is indicated on the type plate.

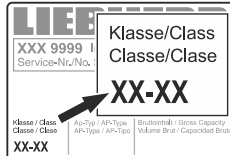

The position of the type plate is shown in the section entitled **Description of the appliance**.

Climate rating	Room temperature
SN	+10°C to +32°C
N	+16°C to +32°C
ST	+16°C to +38°C
T	+16°C to +43°C
SN-ST	+10°C to +38°C
SN-T	+10°C to +43°C

**Do not operate the appliance outside the specified room temperature range.**

## Setting up

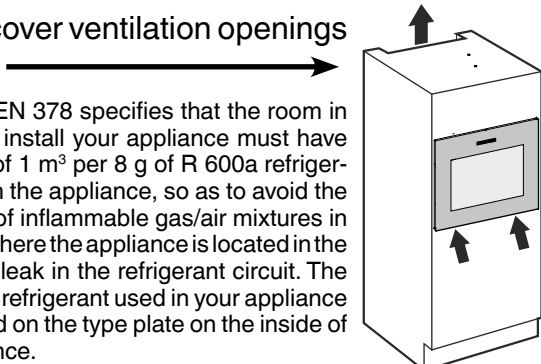
- Avoid positioning the appliance in direct sunlight or near cookers, radiators and similar sources of heat.
- Do not cover ventilation openings or grille. 
- Standard EN 378 specifies that the room in which you install your appliance must have a volume of 1 m<sup>3</sup> per 8 g of R 600a refrigerant used in the appliance, so as to avoid the formation of inflammable gas/air mixtures in the room where the appliance is located in the event of a leak in the refrigerant circuit. The quantity of refrigerant used in your appliance is indicated on the type plate on the inside of the appliance.

## Electrical connection

Only operate the appliance with **alternating current (AC)**.

The permissible voltage and frequency are indicated on the type plate. The position of the type plate is shown in the section entitled **Description of the appliance**.

The socket must be properly earthed and protected by a fuse.

The tripping current of the fuse must be between 10 A and 16 A.

The socket must not be situated behind the appliance and must be easily accessible.

Do not connect the appliance using an extension cable or extension socket.

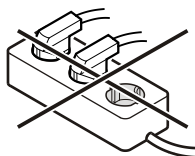

Do not use stand-alone inverters (conversion of direct current to alternating/three-phase current) or energy-saving plugs. Risk of damage to the electronic control system!

## Door opening mechanism (TipOpen)

The TipOpen function is disabled when the appliance is delivered.

The TipOpen function must be enabled after installation in the recess by pressing the On/Off button, see Installation instructions.

### Opening the door

Push the door slightly inwards on the top left-hand side and release again.

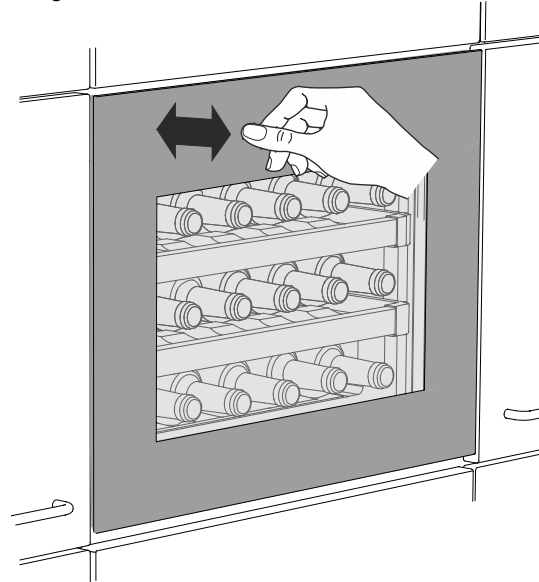

The door is opened approx. 5 cm by the push rod.

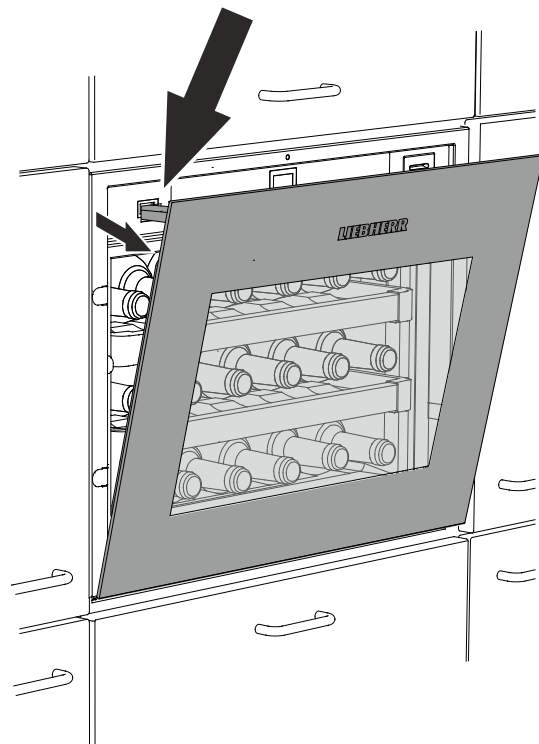

The door can then be fully opened.

### Note

The door will close again automatically after approx. 3 seconds if it has not been fully opened.

### Note on door opening cycles

If the door is closed, it can only be opened again using the TipOpen function after 3 seconds.

## Important notes

**Do not operate the appliance near magnetic fields or place magnetic objects near the appliance.**

**The door may otherwise open when you do not want it to.**

**Do not block the door or hold on to it while it is opening.**

If the door is blocked or held open during opening, the internal safety coupling will be activated.

**Loud, repeated cracking noises will be heard.**

**Do not weigh down the door when it is open.**

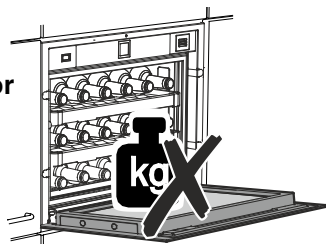

**Do not push the push rod in or hold on to it during closing.**

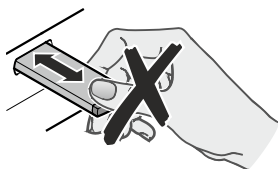

If the push rod is blocked during closing, it will no longer be able to reach its initial position.

In the initial position, the push rod is flush with the front of the appliance.

### Setting the push rod back in its initial position

**Disconnect the appliance from the mains, wait for approx. 5 seconds and plug it back in again.**

The push rod returns to its initial position.

## Operating and control elements

The electronic control panel has the new "touch capacitance technology". Any function can be activated by touching the corresponding icon.

The exact contact point is between the symbol and its label 

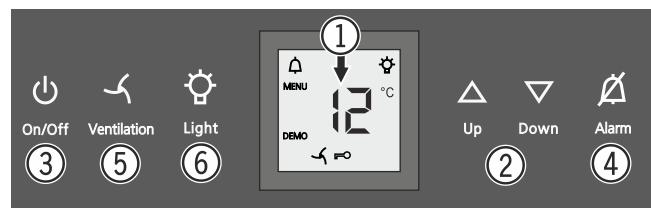

- ① Temperature display
- ② Temperature setting buttons
- ③ On/Off button
- ④ Audible warning On/Off button
- ⑤ Fan button
- ⑥ Interior light On/Off button

### Symbols in the display

 Alarm (symbol flashes if the temperature inside the appliance is too high or too low)

DEMO Demo mode is activated

MENU Setup mode is activated (activating the child lock)

 The interior fan runs constantly

 Child lock is activated

 The interior light is switched on constantly

## Switching the appliance on and off

### Switching the appliance on

Press the **On/Off** button until the temperature display lights up.



### Switching the appliance off

Keep the **On/Off** button pressed for approx. 3 seconds so that the temperature display goes out.

## Setting the temperature

### Increasing the temperature

Press the **Up** button.



### Reducing the temperature

Press the **Down** button.

- When pressing one of the buttons for the first time, the display will start to flash.
- Pressing this button again enables you to change the temperature setting.
- The electronic control system will switch over automatically about 5 seconds after the last time you pressed the button, and the actual temperature will be displayed.

The temperature can be set at between +5°C and +20°C.

## Storing wine

If you are storing wine for long periods of time, it should be stored at a temperature of between 10°C and 14°C.

This is the temperature wine cellars are kept at, and it is just right to allow wine to mature properly.

The following drinking temperatures are recommended for the various types of wine.

Red wines: **+14°C to +18°C**

Rosé wines: **+10°C to +12°C**

White wines: **+8°C to +12°C**

Sparkling wines, Prosecco: **+7°C to +9°C**

Champagne: **+5°C to +7°C**

## Door open alarm

If the door is left open for more than 60 seconds, the audible warning signal will sound.

If the door must be opened for a lengthy period to place items into the appliance, cancel the audible warning signal by pressing the **Alarm** button.



The alarm switches back to standby when the door is shut.

## Temperature alarm

If the temperatures in the interior are out of the permitted range, the audible warning signal will sound and the temperature display will flash.

- Cancel the audible warning signal by pressing the **Alarm** button.

The temperature display will stop flashing as soon as the temperature in the interior has reached the set value.

## Temperature alarm after a fault in the appliance

If the appliance develops a fault, the temperature in the interior may rise too high or fall too low. The audible warning signal will sound and the temperature display will flash.

- Cancel the audible warning signal by pressing the **Alarm** button.

If the temperature display continues to show a value that is too high or too low after one hour, contact the customer service department.

If **F1** appears in the display, the appliance has suffered a fault. In this case, contact the customer service department.

## Fan

The interior fan ensures a constant and even interior temperature and a suitable climate for wine storage.

When activating the **Ventilation** button, the humidity in the appliance is further increased, which has a particularly positive effect for long-term storage.



**Ventilation**

The increased level of humidity prevents the corks from drying out.



### Note

If the appliance is operated in a low ambient temperature, the fan may also run when the fan function is deactivated.

## Child lock

The child lock is designed to protect the appliance from being switched off and the temperature setting from being changed accidentally.

### Activating the child lock



Press  for 5 seconds. Display = 

 Display =  |

 Display = 

 Display = **12** °C  

### Deactivating the child lock

Press  for 5 seconds. Display = 

 Display = 

 Display = 

 Display = **12** °C  

## Interior light

The interior light will always switch on when the appliance door is opened.

The interior light will go out approx. 5 seconds after the door is closed.

Press the **Light** button if you want the interior light to be on even when the door is closed.



Furthermore, the brightness of the lighting can be adjusted.

- Press the **Light** button.
- Press and hold the **Light** button and at the same time press the temperature setting buttons to increase or decrease the brightness.



The light intensity of the LED light corresponds to laser class 1/1M.

### Important

The light cover may only be removed by customer service staff.

If the cover is removed, do not look directly at the light through optical lenses from close distance. This can damage your eyes.

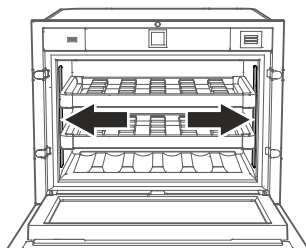

## Storage diagram

for 0.75 l Bordeaux bottles to standard NF H 35-124

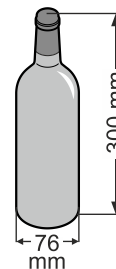
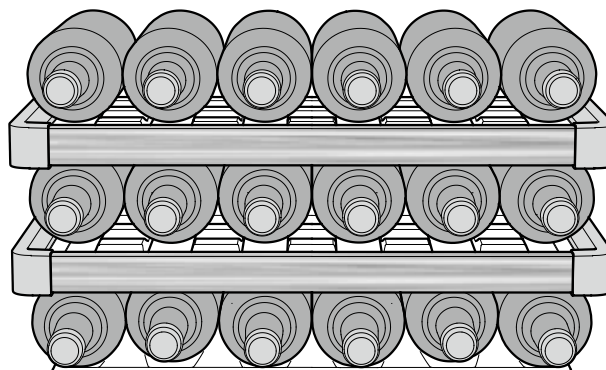

The storage pattern shown above is only possible with the specified bottle size.

Taller bottles must be stored crossways since otherwise the bottles will collide with the appliance door.

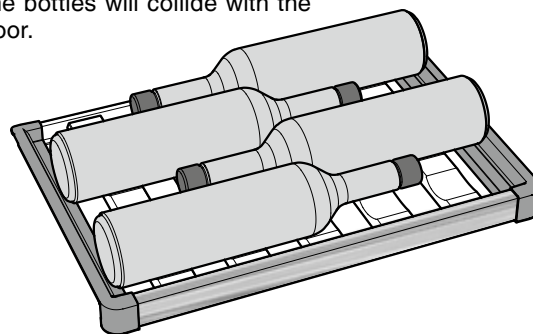

### Important

The maximum load per wooden shelf is 25 kg.

## Air exchange with activated charcoal filter

The way in which wines continue to mature depends on the ambient conditions.

The quality of the air is therefore decisive for preserving the wine.

We recommend that you replace the illustrated filter once a year. Filters can be obtained from your dealer.

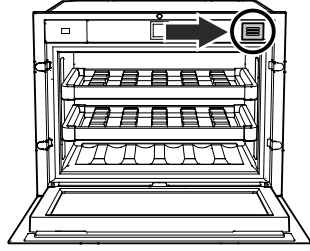

## Changing the filter

- Push the filter in and release it again.

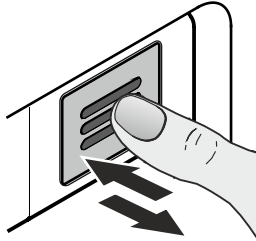

- Pull out the filter.

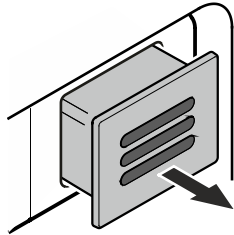

- Remove the back part of the filter.

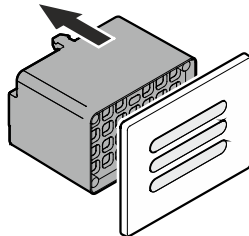

- Fit the new filter to the cover.

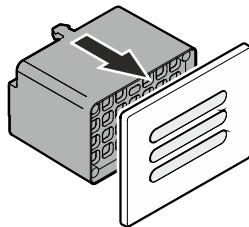

- Insert the filter, push it in as far as it will go and then release it again.

The filter is automatically locked into place.

You will hear a click.

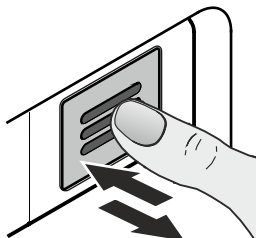

## Cleaning

**Before cleaning, always switch off the appliance. Disconnect from the mains or switch off or unscrew the fuse.**

The wooden shelves can be removed for easier cleaning of the inside of the appliance.

- Raise the appropriate shelf and remove it towards you.
- Take the bottle shelf off the interior floor.
- Clean the inside with lukewarm water and a little detergent.

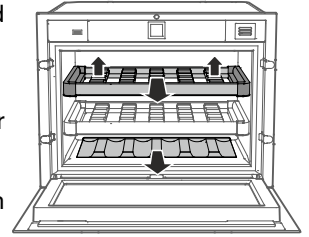

**Do not use abrasive or acid cleaners or chemical solvents.**

- Clean the glass front in the appliance door with a glass cleaner.

## ⚠ CAUTION

**Risk of damage to the appliance components and risk of injury due to hot steam.**

**Do not use steam cleaning equipment to clean the appliance.**

- Ensure that no cleaning water penetrates into the electrical components.
- Clean the pull-out rails with a slightly dampened cloth only. No cleaning water must be allowed to get into the pull-out rail guides.
- Do not damage or remove the type plate on the inside of the appliance. It is very important for servicing purposes.

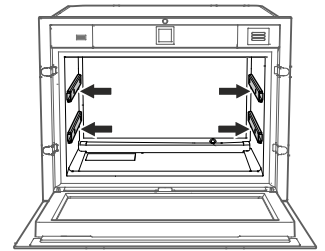

The position of the type plate is shown in the section entitled **Description of the appliance**.

## Inserting the wooden shelves

- Fully slide in the pull-out rails.

Place the wooden shelf on the pull-out rails from above.

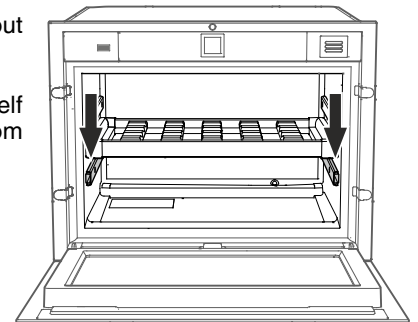



## Malfunctions

- **F1 appears in the display.**
  - The appliance has suffered a fault. Contact the customer service department.
- **The fans inside the appliance are running although the fan function has been deactivated and the compressor (refrigeration unit) is idle.**
  - This is a normal operating state depending on the set interior temperature and ambient temperature at the place of installation.
- **When inserting the mains plug, the refrigeration unit does not switch on, but a value is shown in the temperature display.**
  - Demo mode is activated.  
Contact the customer service department.

**You may be able to rectify the following faults by checking the possible causes yourself.**

- **Appliance does not function:**
  - Is the appliance switched on?
  - Is the plug correctly fitted in the mains socket?
  - Is the fuse intact?
- **Loud running noise:**
  - Is the appliance set up firmly on the floor?
  - Does the appliance cause nearby items of furniture or objects to vibrate? Please note that noises caused by the refrigerant circuit cannot be avoided.
- **The temperature is not low enough:**
  - Is the temperature setting correct (see "Setting the temperature")?
  - Does the separately installed thermometer show the correct reading?
  - Is the ventilation system working properly?
  - Is the appliance set up too close to a heat source?

If none of the above causes apply and you cannot rectify the fault yourself, contact the nearest customer service department stating the type designation ①, service number ② and appliance number ③ as indicated on the type plate.

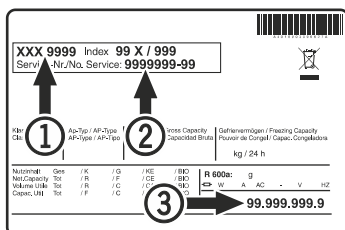

The position of the type plate is shown in the section entitled **Description of the appliance**.

## Shutting your appliance down

If your appliance is to be shut down for any length of time, switch it off and disconnect the plug or switch off or unscrew the fuse.

Clean the appliance and leave the door open in order to prevent unpleasant smells.

The appliance complies with the relevant safety regulations and EC Directives 2004/108/EC and 2006/95/EC.