

Operating instructions

Freezer for integrated use, door-on-door

EN

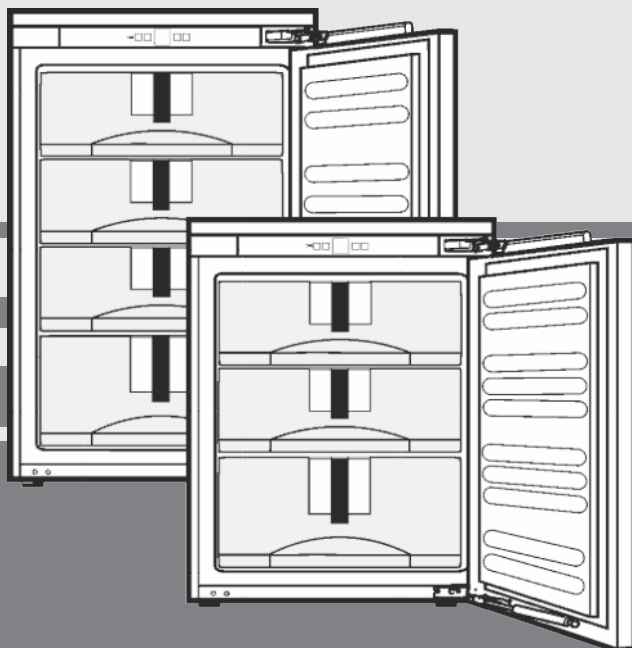

300817 **7086546 - 00**

IGN10/ IGN16/ SIGN35 ... LP

LIEBHERR

Contents

1	Appliance at a glance	2
1.1	Description of appliance and equipment.....	2
1.2	Appliance range of use.....	2
1.3	Conformity.....	3
1.4	Saving energy.....	3
2	General safety information	3
3	Controls and displays	4
3.1	Operating and control elements.....	4
3.2	Temperature display.....	4
4	Putting into operation	4
4.1	Switching on the appliance.....	4
5	Control	4
5.1	Child proofing.....	4
5.2	Door alarm.....	5
5.3	Temperature alarm.....	5
5.4	Freezing food.....	5
5.5	Thawing food.....	5
5.6	Setting the temperature.....	5
5.7	SuperFrost.....	5
5.8	Drawers.....	6
5.9	Shelves.....	6
5.10	VarioSpace.....	6
5.11	Information system.....	6
5.12	Ice cube tray.....	6
5.13	Cold storage accumulators.....	7
6	Maintenance	7
6.1	Defrosting with NoFrost.....	7
6.2	Cleaning the appliance.....	7
6.3	Customer service.....	7
7	Malfunctions	7
8	Decommissioning	8
8.1	Switching off the appliance.....	8
8.2	Taking the appliance out of service.....	8
9	Disposing of the appliance	8

The manufacturer works constantly on the further development of all the types and models. Therefore please understand that we have to reserve the right to make design, equipment and technical modifications.

To get to know all the benefits of your new appliance, please read the information contained in these instructions carefully.

The instructions apply to several models. Differences may occur. Text relating only to specific appliances is marked with an asterisk (*).

Instructions for action are marked with a ►, the results of action are marked with a ▷.

1 Appliance at a glance

1.1 Description of appliance and equipment

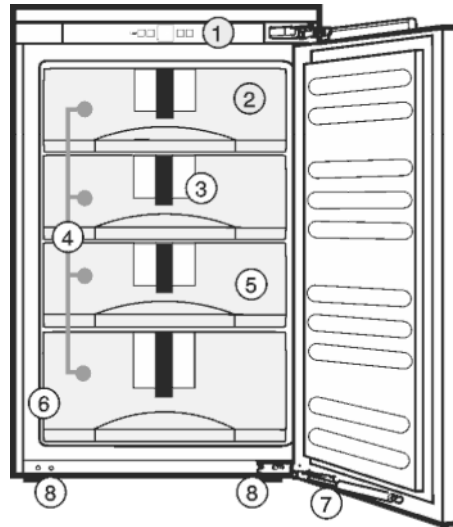

Fig. 1

- | | |
|------------------------------------|----------------------------|
| (1) Operating and control elements | (5) VarioSpace |
| (2) Cold accumulator* | (6) Type plate |
| (3) Info system* | (7) Soft closing fittings* |
| (4) Drawers | (8) Height-adjustable feet |

Note

- Shelves, drawers and baskets are arranged for optimum energy efficiency on delivery.

1.2 Appliance range of use

Intended use

The appliance is only suitable for cooling food products in a domestic or household-like environment. This includes, for example, use:

- in staff kitchens, bed and breakfast establishments,
- by guests in country houses, hotels, motels and other accommodation,
- for catering and similar services in the wholesale trade.

All other types of use are not permitted.

Foreseeable misuse

The following applications are expressly forbidden:

- Storing and refrigerating medicines, blood plasma, laboratory preparations or similar substances and products based on the Medical Device Directive 2007/47/EC
- Use in areas at risk of explosions

Misusing the appliance may lead to damage to the goods stored or they may spoil.

Climate classifications

Depending on the climate classification the appliance is designed to operate in restricted

ambient temperatures. The climate classification applying to your appliance is printed on the rating plate.

Note

► Keep to the specified ambient temperatures in order to guarantee that the appliance works properly.

Climate classification	for ambient temperatures
SN, N	to 32 °C
ST	to 38 °C
T	to 43 °C

The appliance will work properly down to a lower ambient temperature of 5 °C.

1.3 Conformity

The refrigerant circuit has been tested for leaks. In installed condition, this appliance complies with the applicable safety stipulations and with directives 2014/35/EU, 2014/30/EU, 2009/125/EG, 2011/65/EU and 2010/30/EU.

1.4 Saving energy

- Pay attention to good ventilation. Do not cover ventilation holes or grids.
- Do not install the appliance in direct sunlight, next to an oven, radiator or similar.
- Energy consumption is dependent on the installation conditions, e.g. ambient temperature (see 1.2) . If the ambient temperature deviates from the standard temperature of 25°C, the energy consumption may differ.
- Open the appliance for as short a time as possible.
- The lower the temperature is set the higher the energy consumption.
- Arrange the food in an organised way (see Appliance at a glance).
- Keep all food properly packed and covered. This prevents frost from forming.
- Inserting warm food: allow to cool down to room temperature first.

2 General safety information

Danger for the user:

- This device can be used by children and people with impaired physical, sensory or mental abilities or with a lack of experience and knowledge provided that they are supervised or have received instruction in the safe use of this device, and about the resulting hazards. Children must not play with this appliance. Cleaning and user maintenance work must not be carried out by children without adult supervision. Children aged between 3 and 8 are allowed to load and unload the appliance. Children below the age of 3 must be kept away from the appliance

unless they are under continuous adult supervision.

- When disconnecting the appliance from the supply, always take hold of the plug. Do not pull the cable.
- In the event of a fault pull out the mains plug or deactivate the fuse.
- Do not damage the mains power cable. Do not operate the appliance with a defective mains power cable.
- Repairs, interventions on the appliance and the replacement of mains connection line may only be carried out by After-Sales Service or other suitably trained specialist personnel.
- Only install, connect and dispose of the appliance according to the instructions.
- Only use the appliance when it is installed.
- Please keep these instructions in a safe place and pass them on to any subsequent owners.

Fire hazard:

- Refrigerant R 600a is environmentally friendly, but flammable. Leaking refrigerant may ignite.
 - Do not damage the refrigerant circuit pipes.
 - Do not use an open flame or other source of ignition inside the appliance.
 - Do not use electrical appliances inside the appliance (e.g. steam cleaners, heaters, ice cream makers, etc.).
 - If the refrigerant leaks: remove any naked flames or ignition sources from the vicinity of the leakage point. Properly air the room. Inform customer services.
- Do not store explosives or sprays using combustible propellants such as butane, propane, pentane, etc. in the appliance. To identify these spray cans, look for the list of contents printed on the can, or a flame symbol. Gases possibly escaping may ignite due to electrical components.
- Please be sure to store alcoholic drinks or other packaging containing alcohol in tightly closed containers. Any alcohol that leaks out may be ignited by electrical components.

Danger of tipping and falling:

- Do not misuse the plinth, drawers, doors etc. as a step or for support. This applies particularly to children.

Danger of food poisoning:

- Do not consume food which has been stored too long.

Danger of frostbite, numbness and pain:

- Avoid lasting skin contact with cold surfaces or refrigerated/frozen food or take protective steps, e.g. wear gloves. Do not consume ice

Controls and displays

cream, water ice or ice cubes immediately and do not consume them too cold.

Danger of injury and damage:

- Hot steam can lead to injury. Do not use electrical heating or steam cleaning equipment, open flames or defrosting sprays to defrost.
- Do not use sharp implements to remove the ice.



Danger of crushing:

- Do not hold the hinge when opening and closing the door. Fingers may get caught.

Symbols on the appliance:

	The symbol can be located on the compressor. It refers to the oil in the compressor and indicates the following danger: Swallowing or inhaling can be fatal. This is only relevant for recycling. There is no danger in normal operation.
---	---

Please observe the specific information in the other sections:

	DANGER	identifies a situation involving direct danger which, if not obviated, may result in death or severe bodily injury.
	WARNING	identifies a dangerous situation which, if not obviated, may result in death or severe bodily injury.
	CAUTION	identifies a dangerous situation which, if not obviated, may result in minor or medium bodily injury.
	NOTICE	identifies a dangerous situation which, if not obviated, may result in damage to property.
	Note	identifies useful information and tips.

3 Controls and displays

3.1 Operating and control elements

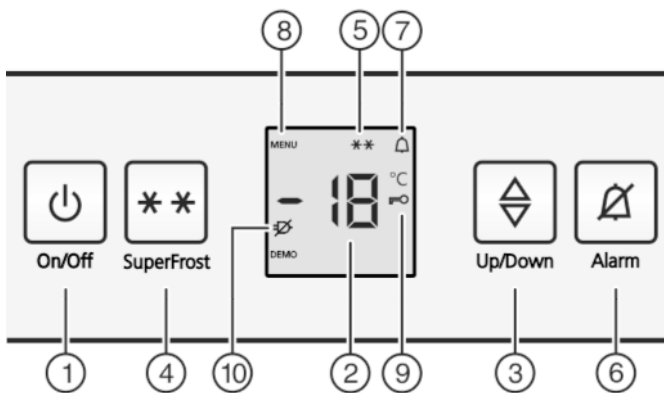

Fig. 2

- | | |
|-------------------------|---------------------------|
| (1) On/Off button | (6) Alarm button |
| (2) Temperature display | (7) Alarm symbol |
| (3) Up/Down button | (8) Menu symbol |
| (4) SuperFrost button | (9) Child lock symbol |
| (5) SuperFrost symbol | (10) Power failure symbol |

3.2 Temperature display

During normal operation, the display shows:

- the highest freezing temperature

The temperature display flashes if/when:

- You change the temperature setting
- The appliance is not cold enough after switching on
- The temperature rises by several degrees

Stripes flash in the display if/when:

- The freezer temperature exceeds 0 °C.

The following displays indicate a fault. Possible causes and solutions: (see Malfunction).

- F0 to F9
- The power failure symbol  flashes.

4 Putting into operation

4.1 Switching on the appliance

- ▶ Open the door.
- ▶ Press the On/Off button *Fig. 2 (1)*.
- ▷ The temperature display lights up. The appliance is switched on.
- ▷ If "DEMO" is displayed, demo mode is activated. Please contact the after sales service.



5 Control

5.1 Child proofing

The child-proofing function enables you to make sure that the appliance is not inadvertently switched off by playing children.



5.1.1 Setting the child lock

To switch on the function:

- ▶ Activate setting mode: press the SuperFrost button *Fig. 2 (4)* for approx. 5 seconds.
- ▷ The Menu symbol *Fig. 2 (8)* is shown on the display.
- ▷ c flashes on the display.
- ▶ Briefly confirm with the SuperFrost button, *Fig. 2 (4)*.
- ▷ cl appears in the display.
- ▶ Briefly confirm with the SuperFrost button, *Fig. 2 (4)*.
- ▷ The child lock symbol *Fig. 2 (9)*, lights up on the display.
- ▷ c flashes on the display.
- ▷ The child lock function is switched on. If setting mode is to be terminated:
- ▶ Briefly press the On/Off button *Fig. 2 (1)*.

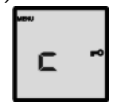

-or-

- ▶ Wait for 5 minutes.
- ▷ The temperature display shows the temperature again.

To switch off the function:

- ▶ Activate setting mode: press the SuperFrost button *Fig. 2 (4)* for approx. 5 seconds.
- ▷ The Menu symbol *Fig. 2 (8)* is shown on the display.
- ▷ c flashes on the display.
- ▶ Briefly confirm with the SuperFrost button, *Fig. 2 (4)*.
- ▷ c0 appears in the display.
- ▶ Briefly confirm with the SuperFrost button, *Fig. 2 (4)*.
- ▷ The child lock symbol *Fig. 2 (9)* goes out.

- ▷ **c** flashes on the display.
- ▷ The child lock function is switched off.
If setting mode is to be terminated:
- ▶ Briefly press the On/Off button *Fig. 2 (1)*.
- or-
- ▶ Wait for 5 minutes.
- ▷ The temperature display shows the temperature again.

5.2 Door alarm

An audible warning sounds if the door is open for longer than 60 seconds.

The audible warning stops automatically when the door is closed.



5.2.1 Muting the door alarm

The audible alarm can be muted when the door is open. The sound switch-off function is active as long as the door is left open.

- ▶ Press alarm button *Fig. 2 (6)*.
- ▷ The door alarm is silenced.

5.3 Temperature alarm

The audible alarm sounds if the freezer temperature is not cold enough.

The temperature display and the alarm symbol *Fig. 2 (7)* flash at the same time.



The cause of the temperature being too high may be:

- warm fresh food was placed inside
- too much warm ambient air flowed in when rearranging and removing food
- power failure for some time
- the appliance is faulty

The audible alarm is automatically silenced, the alarm symbol *Fig. 2 (7)* goes out and the temperature display stops flashing when the temperature is sufficiently cold again.

If the alarm status persists: (see Malfunction).

Note

- Food may be spoilt if the temperature is not cold enough.
- ▶ Check the quality of the food. Do not consume spoiled food.

5.3.1 Muting the temperature alarm

The audible alarm can be muted. When the temperature is sufficiently cold again, the alarm function is active again.

- ▶ Press alarm button *Fig. 2 (6)*.
- ▷ The audible alarm is silenced.

5.4 Freezing food

The rating plate indicates the maximum quantity of fresh food you can freeze within 24 hours (see Appliance at a glance) under "Freezing capacity ... kg/24h".

The maximum load of frozen food for the drawers is 25 kg each and for the shelves 35 kg each.

A vacuum is generated after the door is closed. After closing the door, wait for about 1 minute and then it opens more easily.



CAUTION

- Risk of injury due to broken glass!
- Bottles and cans containing drinks may burst when being frozen. This applies particularly to sparkling drinks.
- ▶ Do not freeze bottles and cans containing drinks!

In order that the food is rapidly frozen through to the core, do not exceed the following quantities per pack:

- Fruit, vegetables up to 1 kg
- Meat up to 2.5 kg
- ▶ Pack the food in portions in freezer bags, reusable plastic, metal or aluminium containers.

5.5 Thawing food

- in the refrigerator compartment
- in a microwave oven
- in a conventional or fan oven
- at room temperature
- ▶ Remove only as much food as is required. Use thawed food as quickly as possible.
- ▶ Food once thawed should be re-frozen only in exceptional cases.

5.6 Setting the temperature

The temperature depends on the following factors:

- the frequency of opening the door
- the room temperature of the installation location
- the type, temperature and quantity of the food

Recommended temperature setting: -18 °C

The temperature can be adjusted continually. Once the -28 °C setting is reached, the sequence starts again at -15 °C .

- ▶ Call up the temperature function by pressing the adjustment button *Fig. 2 (3)* once.
- ▷ The previously-set value will flash in the temperature display.
- ▶ Change temperature in 1 °C steps: press the setting button (j) until the required temperature is indicated in the temperature display.
- ▶ Change temperature continually: hold down setting button.
- ▷ During adjustment the value flashes on the display.
- ▷ The new setting is adopted approx. 5 seconds after the last time the button was pressed and the set temperature is again displayed. The temperature in the interior gradually adjusts to the new value.



5.7 SuperFrost

With this function you can freeze fresh food quickly through to the core. The appliance operates with maximum refrigeration. The noise of the refrigeration unit may be temporarily louder as a result. ❄ ❄

You can freeze as many kilograms of fresh food within 24 hrs as is indicated on the type plate under "Freezing capacity ... kg/24hrs". This maximum freezing quantity can vary depending on model and climate class.

You have to activate SuperFrost in good time, depending on how much fresh food is to be frozen: about 6 hours before placing the food inside in case of small amounts and about 24 hours in advance in case of the maximum amount of food to be frozen.

Wrap produce and spread it out as far as possible. Do not allow produce to be frozen to touch produce that is already frozen to prevent the latter thawing.

You do not have to activate SuperFrost in the following cases:

- when placing frozen food in the freezer
- when freezing up to approx. 2 kg fresh food daily

5.7.1 Freezing with SuperFrost

- ▶ Briefly press the SuperFrost button *Fig. 2 (4)* once.
- ▷ The SuperFrost symbol *Fig. 2 (5)* shines.
- ▷ The freezing temperature drops, the appliance operates with the maximum cooling capacity.

Control

- For a smaller quantity of produce to be frozen:
 - ▶ wait approx. 6 h.
 - ▶ Place wrapped produce in the deep bottom drawers.
- For the maximum quantity of produce to be frozen:
 - ▶ wait approx. 24 h.
 - ▶ Remove the deep bottom drawers and place produce directly on the bottom shelves.
- ▷ SuperFrost is automatically deactivated after 65 hours.
- ▷ The SuperFrost symbol *Fig. 2 (5)* extinguishes once freezing is completed.
- ▶ Place produce in the drawers and push the latter back in again.
- ▷ The appliance continues to operate in the energy-saving, normal mode.

5.8 Drawers

Note

The energy consumption increases and the cooling performance reduces if the air ventilation is insufficient.

- ▶ Ensure that the air slits of the fan on the rear wall are always kept free!

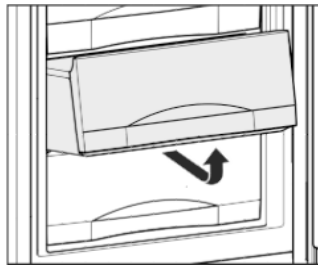

- ▶ To store frozen food directly on the shelves: pull the drawer forwards and lift it out.

5.9 Shelves

5.9.1 Moving shelves

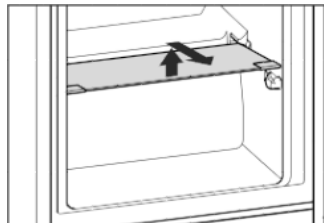

- ▶ To remove the shelf: lift up at the front and pull out.

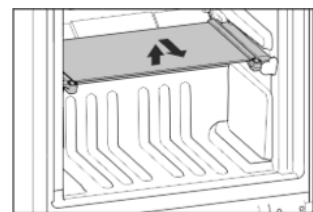

- ▶ To put the shelf back: simply push in as far as it will go.

5.9.2 Removing shelves*

- ▶ The shelves may be removed for cleaning.

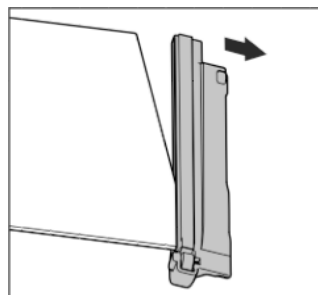

5.10 VarioSpace

Apart from being able to remove the drawers, you can also remove the shelves, creating space for large items of frozen food. Poultry, meat, large pieces of game and high bakery products can be frozen in one piece and prepared.

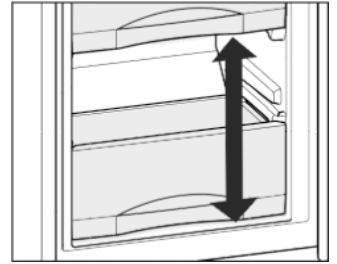

- ▶ The maximum load of frozen food for the drawers is 25 kg each and for the shelves 35 kg each.

5.11 Information system*

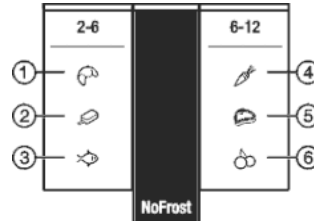

Fig. 3

- | | |
|---------------|----------------|
| (1) Bread | (4) Vegetables |
| (2) Ice cream | (5) Meat |
| (3) Fish | (6) Fruit |

The figures indicate the storage time in months for several types of frozen food in each case. Storage times given are guide times.

5.12 Ice cube tray

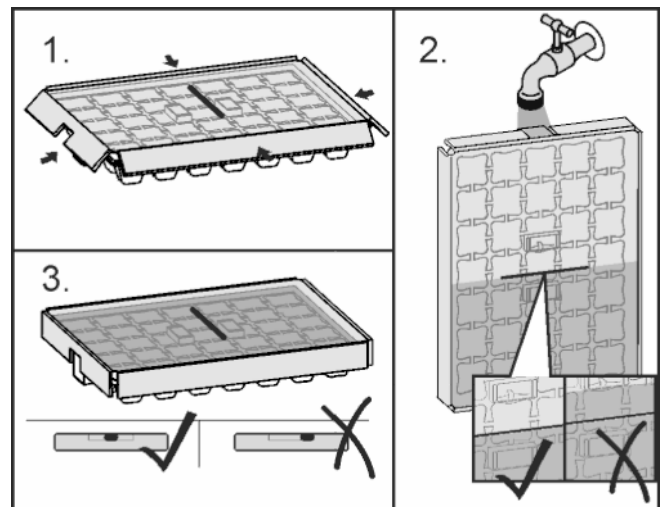

Fig. 4

When the water is frozen:

- ▶ Hold ice cube tray under hot water for a short time.
- ▶ Remove the lid.
- ▶ Gently turn the ends of the ice cube tray in opposite directions and release the cubes.

Dismantling the ice cube tray

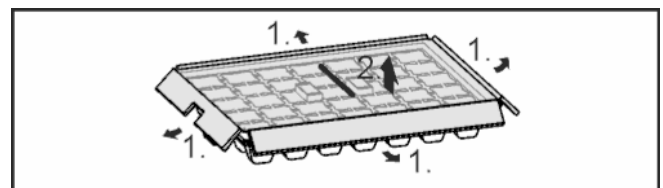

Fig. 5

- ▶ You can take the ice cube tray apart for cleaning.

5.13 Cold storage accumulators*

The cold storage accumulators prevent the temperature from rising too fast in the event of power failure.

5.13.1 Using cold storage accumulators*

- ▶ Place the frozen cold storage accumulators on the frozen food in the upper front area of the freezer compartment.

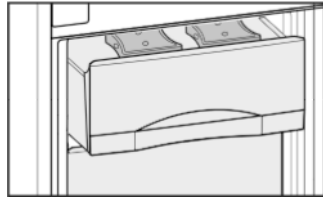

6 Maintenance

6.1 Defrosting with NoFrost

The NoFrost system automatically defrosts the appliance. The moisture condenses on the evaporator, is periodically defrosted and evaporates.

- ▶ The appliance does not have to be manually defrosted.

6.2 Cleaning the appliance



WARNING

Risk of injury and damage as a result of hot steam! Hot steam can lead to burns and can damage the surfaces.

- ▶ Do not use any steam cleaners!

NOTICE

Incorrect cleaning damages the appliance!

- ▶ Do not use cleaning agents in concentrated form.
- ▶ Do not use any scouring or abrasive sponges or steel wool.
- ▶ Do not use any sharp or abrasive cleaning agents, nor any that contain sand, chloride or acid.
- ▶ Do not use chemical solvents.
- ▶ Do not damage or remove the type plate on the inside of the appliance. It is important for the customer service.
- ▶ Do not pull off, bend or damage cables or other components.
- ▶ Do not allow any cleaning water to enter the drain channel, ventilation grille or electrical parts.
- ▶ Please use soft cleaning cloths and a universal pH-neutral cleaning agent.
- ▶ Please use cleaning and care products suitable for contact with foodstuffs in the appliance interior.

- ▶ **Empty appliance.**
- ▶ **Pull out the power plug.**



- ▶ Clean the **vent grille** regularly.
- ▷ Dust deposits increase energy consumption.
- ▶ Clean **plastic outer and inner surfaces** with lukewarm water and a little washing-up liquid.
- ▶ Clean **items of equipment** by hand with lukewarm water and a little washing-up liquid.

After cleaning:

- ▶ Wipe dry the appliance and items of equipment.
- ▶ Connect the appliance and switch it on again.
- ▶ Switch on SuperFrost (see 5.7).
- ▶ When the temperature is sufficiently cold:
- ▶ Put the food back inside.

6.3 Customer service

First check whether you can correct the fault yourself by reference to the list (see Malfunction). If this is not the case, please contact the customer service whose address is given in the enclosed customer service list.



WARNING

Risk of injury if repair work is not carried out professionally!

- ▶ Have any repairs and action - not expressly specified - on the appliance and mains cable carried out by service personnel only. (see Maintenance)

- ▶ Read the appliance designation *Fig. 6 (1)*, service No. *Fig. 6 (2)* and serial No. *Fig. 6 (3)* off the type plate located inside the appliance on the left-hand side.

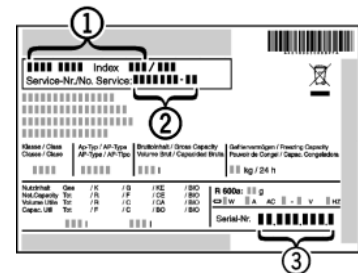

Fig. 6

- ▶ Notify the customer service, specifying the fault, appliance designation *Fig. 6 (1)*, service No. *Fig. 6 (2)* and serial No. *Fig. 6 (3)*.
- ▷ This will help us to provide you with a faster and more accurate service.
- ▶ Keep the appliance closed until the customer service arrives.
- ▷ The food will stay cool longer.
- ▶ Pull out the mains plug (not by pulling the connecting cable) or switch off the fuse.

7 Malfunctions

Your appliance is designed and manufactured for a long life span and reliable operation. If a malfunction nonetheless occurs during operation, check whether it is due to a handling error. In this case you will have to be charged for the costs incurred, even during the warranty period. You may be able to rectify the following faults yourself:

Appliance does not work.

- The appliance is not switched on.
- ▶ Switch on the appliance.
- The power plug is not properly inserted in the wall socket.
- ▶ Check power plug.
- The fuse of the wall socket is not in order.
- ▶ Check fuse.

The compressor runs for a long time.

- The compressor switches to a low speed when little cold is needed. Although the running time is increased as a result, energy is saved.
- ▶ This is normal in energy-saving models.
- SuperFrost is activated.
- ▶ The compressor runs for longer in order to rapidly cool the food. This is normal.

A LED on the bottom rear of the appliance (at the compressor) flashes repeatedly every 5 seconds*.

- There is a fault.
- ▶ Please contact the after-sales service (see Maintenance).

Excessive noise.

- Due to the various speed steps, speed-regulated* compressors can generate different running noises.
- ▶ The sound is normal.

Decommissioning

A bubbling and gurgling noise.

- This noise comes from the refrigerant flowing in the refrigeration circuit.
- ▶ The sound is normal.

A quiet clicking noise.

- The noise is produced whenever the refrigeration unit (motor) automatically switches on or off.
- ▶ The sound is normal.

A hum. It is briefly a little louder when the refrigeration unit (the motor) switches on.

- The refrigeration increases automatically when the SuperFrost function is activated, fresh food has just been placed in the appliance or the door has been left open for a while.
- ▶ The sound is normal.
- The ambient temperature is too high.
- ▶ Solution: (see 1.2)

A low hum.

- The sound is produced by air flow noise of the fan.
- ▶ The sound is normal.

Vibration noises

- The appliance is not standing firmly on the floor. As a result objects and adjacent units start to vibrate when the refrigerator is running.
- ▶ Check the installation and realign the appliance.
- ▶ Keep bottles and jars apart.

Flow sound at the soft stop mechanism.*

- The noise is produced when the door is opened and closed.
- ▶ The sound is normal.

The temperature display indicates: F0 to F9

- There is a fault.
- ▶ Please contact the after-sales service (see Maintenance).

Power failure flashes in the temperature display . The highest temperature reached during power failure is indicated in the temperature display.

- The freezer temperature rose too high over the last hours or days due to a power failure or power interruption. When the power interruption is over, the appliance will continue to operate in the last temperature setting.
- ▶ To cancel the display of the warmest temperature: press alarm button *Fig. 2 (6)*.
- ▶ Check the quality of the food. Do not consume spoiled food. Do not re-freeze thawed food.

DEMO shines in the temperature display.

- The demo mode is activated.
- ▶ Please contact the after-sales service (see Maintenance).

The outer surfaces of the appliance are warm*.

- The heat of the refrigeration circuit is used to prevent condensate from forming.
- ▶ This is normal.

The temperature is not cold enough.

- The door of the appliance is not properly closed.
- ▶ Close the door of the appliance.
- Insufficient ventilation.
- ▶ Keep ventilation grille clear, and clean it.
- The ambient temperature is too high.
- ▶ Solution: (see 1.2) .
- The appliance was opened too frequently or for too long.
- ▶ Wait to see whether the appliance reaches the required temperature by itself. If not, please contact the after sales service (see Maintenance).
- Too much fresh food was placed inside without SuperFrost.
- ▶ Solution: (see 5.7)
- The temperature is incorrectly set.

- ▶ Set the temperature to a colder setting and check after 24 hours.
- The appliance is too close to a source of heat (stove, heater etc).
- ▶ Change the position of the appliance or the source of heat.
- The appliance was not inserted properly into the recess.
- ▶ Check whether the appliance was inserted correctly and the door closes properly.

8 Decommissioning

8.1 Switching off the appliance

- ▶ Press On/Off button *Fig. 2 (1)* for approx. 2 seconds.
- ▷ A long beep is emitted. The temperature display is dark. The appliance is switched off.
- ▷ If the appliance cannot be switched off, the child lock function is active (see 5.1) .



8.2 Taking the appliance out of service

- ▶ Empty the appliance.
- ▶ Switch off the appliance (see Decommissioning).
- ▶ Remove mains connector.
- ▶ Clean the appliance (see 6.2) .



- ▶ Leave the door open to prevent odour.

9 Disposing of the appliance

The appliance contains some reusable materials and should be disposed of properly - not simply with unsorted household refuse. Appliances which are no longer needed must be disposed of in a professional and appropriate way, in accordance with the current local regulations and laws.



When disposing of the appliance, ensure that the refrigeration circuit is not damaged to prevent uncontrolled escape of the refrigerant it contains (data on type plate) and oil.

- ▶ Disable the appliance.
- ▶ Pull out the plug.
- ▶ Cut through the connecting cable.



Liebherr-Hausgeräte Ochsenhausen GmbH

Memminger Straße 77-79

88416 Ochsenhausen

Deutschland

home.liebherr.com