



- en Instructions for use
- rus Руководство по эксплуатации
- ua Інструкції з експлуатації
- cz Návod k obsluze
- sk Návod na obsluhu
- pl Instrukcja obsługi
- hu Használati útmutató



Dear customer!

This electric integrated gas cooker is manufactured for household use. Our appliances are packed in the environmentally friendly materials which may be recycled, deposited or destroyed without any hazard to the environment. Such packaging materials are also labeled accordingly. Once the life cycle your appliance is over, make sure not to pollute the environment, and deliver it to the authorized collectors of old household appliances.

Instructions for use

Instructions for use have been prepared for the user, and describe the appliance and the way it is handled. These instructions are intended for various types of the appliance, so you may find some descriptions for the functions that your particular appliance may not have.

These instructions are only valid if the country symbol is indicated on the appliance. If there is NO country symbol in the appliance, technical instructions should be observed for adapting the appliance to comply with the requirements and regulations for use in your country.

Instructions for connection

The appliance must be connected in compliance with the instructions attached to it, as well as in compliance with relevant regulations and standards. The connection may only be performed by a qualified person.

Rating plate

The rating plate indicating the basic information on the appliance is attached to the lower side of the hob.

| | |
|---|-----------|
| Important warnings | 3 |
| Installation | 4 |
| Connecting the appliance to the power mains | 5 |
| Connecting the cooking hob to the gas supply | 6 |
| Nozzle table | 8 |
| Technical information | 8 |
| Appliance description | 9 |
| Cleaning and maintenance | 11 |
| Special warnings and fault reporting | 13 |

TECHNICAL INSTRUCTIONS AND INSTALLATION

Important warnings

- Installation of the appliance into a kitchen worktop and its connection to the power mains and the gas supply may only be performed by an adequately qualified technician.
- When the appliance is in use, additional heat and moisture are emitted into the room. When the appliance is used for a prolonged period of time at a high performance level, intensive ventilation or use of kitchen hood may be required in the room where the appliance is installed.
- Do not use the gas burners, if the flame seems unstable.
- If you smell gas in the room, immediately close the gas supply valve either on the gas bottle or gas pipeline, extinguish all sources of open fire (including cigarettes), aerate the room, do not turn on any electric appliances, and call a natural gas expert.
- The main gas supply valve should also be closed if gas burners will be out of use for a long period of time (e.g. when going on holiday).
- Do not leave small children unattended when the appliance is in operation. Risk of burning and scalding!
- During cooking, the overheated fat or oil on the hob may ignite. There is a risk of burning and fire; therefore, control the cooking process at all times.
- Do not use the cooking hob for room heating.
- Do not place empty pans on the hob.
- Make sure that the parts of the burners are correctly positioned / installed.
- Glass ceramic hobs should not be used as a worktop. Sharp objects may cause scratches.
- Preparing food in thin aluminum or plastic containers on hot cooking zones is not allowed. Do not place any plastic objects or aluminum foil on the glass ceramic hob.
- If there is a wall power outlet located near the hob and another appliance is plugged into it, make sure the power cord does not come into contact with the hot cooking zones.
- Do not store any temperature-sensitive objects, materials, or substances underneath the hob, e.g. detergents, sprays, etc.
- Do not use the glass ceramic hob if it is cracked or broken. If any visible crack appears, immediately unplug and disconnect the appliance from the power supply to avoid the possibility of electric shock.
- In case of a failure of the appliance, immediately disconnect the appliance from the power mains and contact the service center.
- Do not use steam cleaners or high-pressure cleaners to clean the cooking hob, as this may result in an electric shock.
- The appliance is manufactured in compliance with the relevant effective safety standards.
- The appliance is not intended for use by persons (including children) with reduced physical, sensory or mental capabilities, or lack of experience and knowledge, unless they have been given supervision or instruction concerning use of the appliance by a person responsible for their safety.
- Children should be supervised to ensure that they do not play with the appliance.
- After a prolonged use of cast iron plates, the area of the plate and the edge of the cooking zone may discolour. Repair service is not covered by the warranty.
- The hob can not be activated by external timers or remote controls systems.



The symbol on the product or on its packaging indicates that this product may not be treated as household waste. Instead it shall be handed over to the applicable collection point for the recycling of electrical and electronic equipment. By ensuring this product is disposed of correctly, you will help prevent potential negative consequences for the environment and human health, which could otherwise be caused by inappropriate waste handling of this product. For more detailed information about recycling of this product, please contact your local city office, your household waste disposal service or the shop where you purchased the product.

INSTALLATION

Important warnings

- Installation of the appliance into a kitchen worktop and its connection to the power mains may only be performed by an adequately qualified technician.
- Veneer or other finish of the piece of kitchen furniture into which the hob is to be built in should be treated with heat resistant glue (100°C); otherwise, the worktop finish may be discolored or deformed.
- Cooking hob is dimensioned to be built into the worktop over a piece of kitchen furniture, with a width of 600 mm or more.
- After installation, the front two fastening elements should be freely accessible from below.
- The kitchen furniture element underneath the hob should not be fitted with a drawer. If the kitchen furniture element as a horizontal partition wall, it should be installed no less than min 20mm from the lower surface of the worktop. The space between the partition wall and the hob must be empty; no objects should be placed into that gap.
- Hanging, or wall-mounted kitchen elements should be installed high enough not to interfere with the work process.
- The distance between the cooking hob and the kitchen hood should be no less than indicated in the instructions for kitchen hood installation. The minimum distance is 700 mm.
- The distance between the appliance edge and the adjacent tall kitchen furniture element should amount to no less than 150 mm.
- Use of massive wood decoration plates or boards on the worktops behind the cooking hob is permitted, if the minimum distance remains the same as indicated in the installation drawings.
- Minimum distance between the built-in cooking hob and the rear wall is indicated on the installation drawing.
- Cooking hobs can be installed into worktops that are 25 to 40 mm thick. The front part must have an opening of no less than 5 mm.

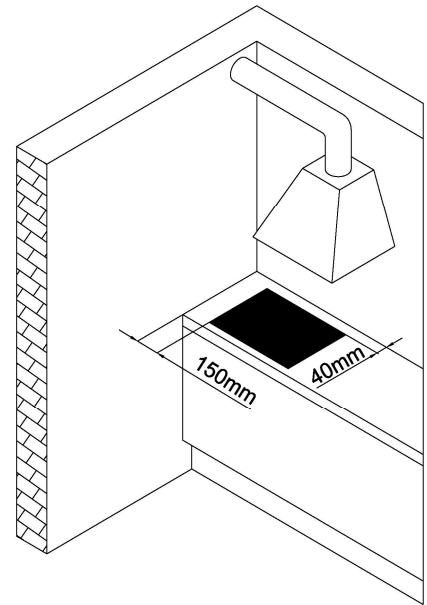
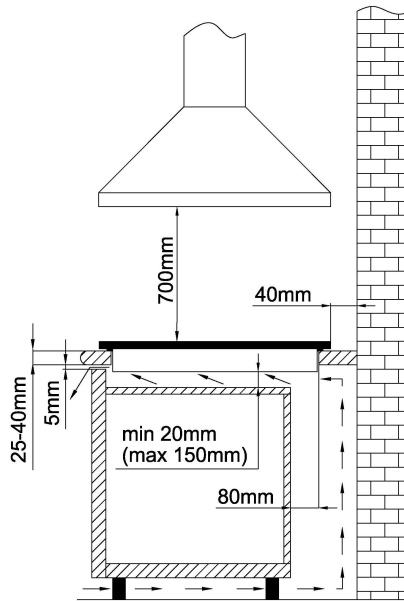
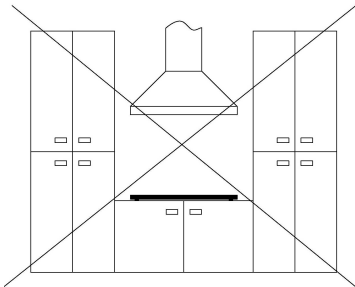

| | GKTG6SY2B | GKTG6SY2W |
|---------------|-----------|-----------|
| A (mm) | 585 | 585 |
| B (mm) | 510 | 510 |
| C (mm) | 560 | 560 |
| D (mm) | 480 | 480 |
| E (mm) | 40 | 40 |
| F (mm) | 9 | 9 |
| G (mm) | 50 | 50 |

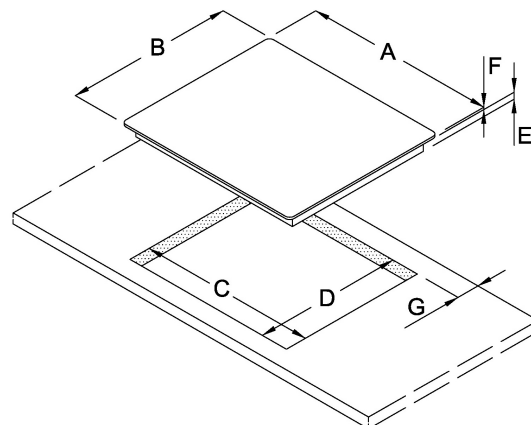

Installing the foam gasket

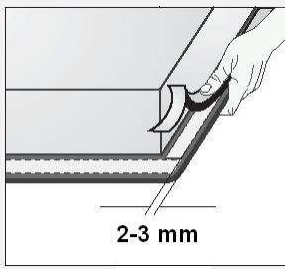

Kitchen worktop cutoff dimensions

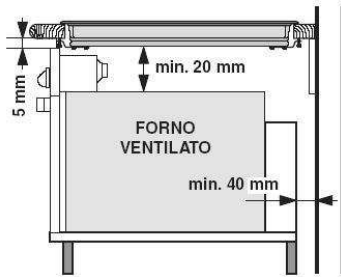

Installation procedure (with springs)

Before inserting the appliance into the opening in the kitchen worktop, the supplied foam gasket must be attached to the lower side of the glass ceramic (glass) cooking hob (see figure above).

Do not install the appliance without the foam gasket!

The gasket should be attached to the appliance in the following way:

- Remove the protective film from the gasket.
- Then, attach the gasket to the lower side of the glass, approximately 2-3 millimetres from the edge (as shown in the figure). The gasket must be attached along the entire length of the glass edge and should not overlap at the corners.
- When installing the gasket, make sure that the glass does not come into contact with any sharp objects.

- Only ovens fitted with a cooling fan may be installed underneath this cooking hob.
- Before installing an oven, the rear wall of the kitchen furniture element should be removed in the area of the cooking hob cutout. Furthermore, a gap of at least 5 mm should be left at the front side.

- Worktop must be placed absolutely horizontal.
- Suitably protect the edges of the cut aperture.
- Connect the cooking hob to the mains power supply (see instructions for the connection of the cooking hob to mains power supply).
- Put the supplied springs in their places.
- Insert the hob into the cut aperture.
- Press the hob firmly towards the worktop from above.

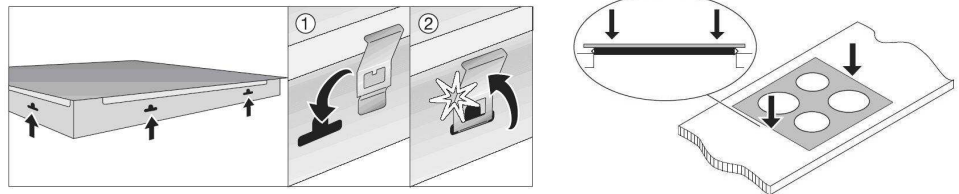

Installation procedure (with fixing brackets)

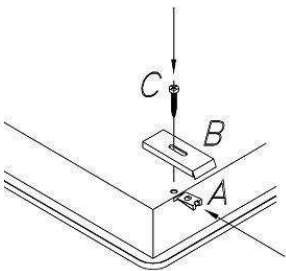

The cook top is fixed to the unit by means of the brackets and accessories provided. Holes are provided in the bottom of the tray where the self-threading plates (A) are inserted so that you can attach the screws (C) that hold the brackets (B) in place.

- A** = plates for inserting on the bottom of the cook top
- B** = fixing bracket
- C** = screw

CONNECTING THE APPLIANCE TO THE POWER MAINS

- The appliance may only be connected by an authorized skilled technician.
- Electric system protection should comply with all relevant regulations.
- The connection clips can be accessed when the connection clip covers are opened / removed.
- Before connecting the appliance, make sure the voltage indicated on the rating plate is consistent with the voltage in your home circuit.
- The rating plate with basic information is attached on the lower side of the hob.
- The appliance is manufactured for use with the power supply voltage 220-240 V ~.
- In order to make a fixed connection to the mains, insert an all-pole circuit breaker between the appliance and the mains. This device shall have a contact separation in all poles, providing full disconnection under overvoltage category III conditions.
- Given the protection from the risk of fire, appliances of this type may be installed in a worktop next to a piece of kitchen furniture that is taller than the appliance (when installed); however, in this case, a kitchen furniture element must be installed on the

other side, adjacent to the appliance.

- The current conducting and isolated parts must be protected from any possibility of direct contact.

WARNING!

- Before any intervention, disconnect the appliance from the power mains. Connect the appliance in compliance with the electric connections diagram supplied; make sure the relevant network voltage is observed! The ground wire (PE) should be connected to the clip indicated by the earthing symbol.
- The mains cable should be fed through the fastening clip which protects it from being accidentally pulled out.
- After connecting the appliance, turn on all cooking zones / heaters for approximately three minutes to make sure they are operating correctly.

Connecting:

230 V~ 3x1.5 mm

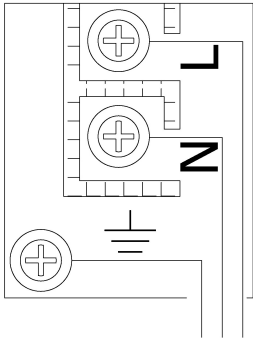

- Incorrect connection may destroy parts of the appliance, making the warranty void.
- Before connecting the appliance, make sure the voltage indicated on the rating plate is consistent with the voltage in your home network. Connection voltage should be checked by a qualified technician using a corresponding measuring device!
- Connection cable on the back of the appliance should be led in such way that it does not touch the appliance back wall, as this part will get very hot during operation.

The following can be used for connection:

- Type H05RR-F rubber connection cables with a greenyellow protective wire,
- Type H07RN-F rubber connection cables with a greenyellow protective wire.

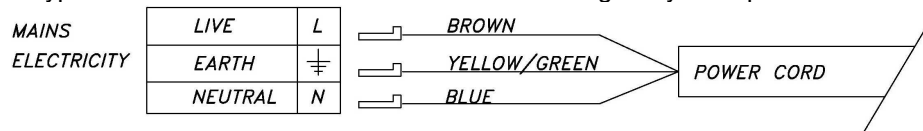

CONNECTING THE COOKING HOB TO THE GAS SUPPLY

- The appliance must be connected in compliance with all relevant regulations, and it may only be used in well ventilated / aerated rooms. Before connecting or using the appliance, please read the instruction manual.
- Before installing and connecting, make sure the local natural gas supply network and connection (type of gas and pressure), are compatible with your appliance version.

The category with the related types of gas can be used are included in Table 1

- The version of this appliance is indicated on the rating plate.
- This appliance is not suitable for connection to a burning fumes exhaust system (i.e. a chimney).

The appliance must be installed and connected in compliance with the relevant effective installation regulations. Special care must be taken to ensure adequate ventilation / aeration.

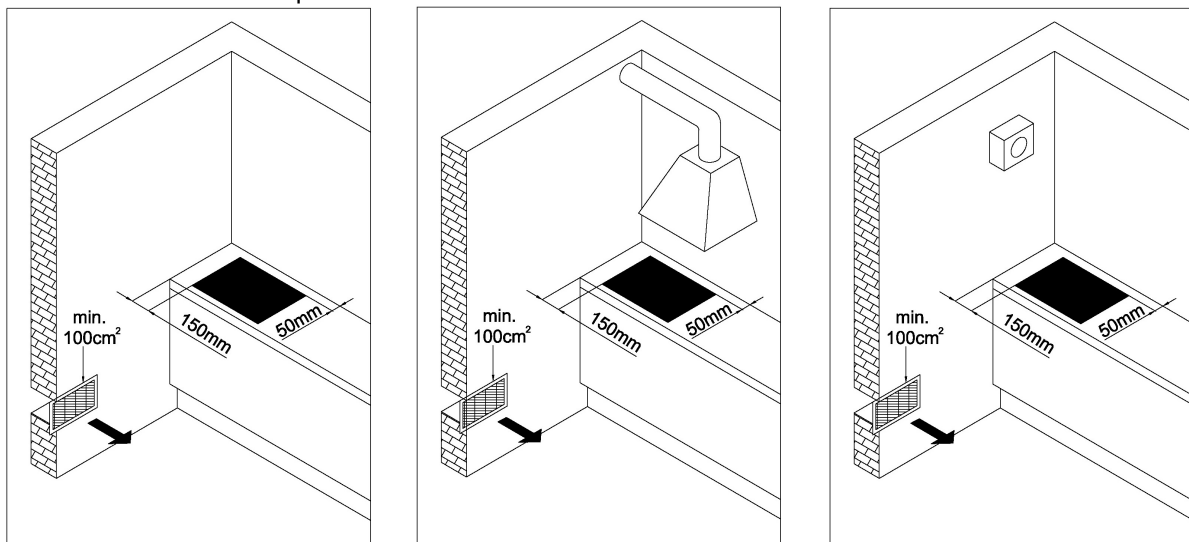

Connection

- When connecting the appliance to the gas supply, follow the regulations of the local gas distributor.
- On the lower side, the cooking hob is fitted with a gas connection plug with a ISO7-1 R1/2 thread.
- Also supplied with the appliance is an adapter for liquid gas, a taper male, and a non-metal gasket.

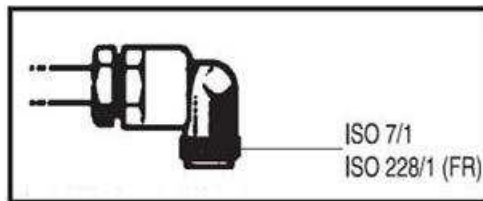

- When connecting, the knee R1/2 should be held firmly to prevent it from rotating.
- For sealing of the connection joints, use a non-metal approved gaskets and approved sealants.
- The gaskets should only be used once. The thickness of the flat non-metal gaskets should not be deformed more than by 25 percent.
- To connect the appliance to the gas supply, use a tested and certified flexible hose.
- The flexible connection hose should be able to move freely. It should not come into contact with the movable parts of the furniture or the bottom of the cooking hob.
- If an electric oven is built into the kitchen element under the cooking hob, it should be fitted with a cooling fan.

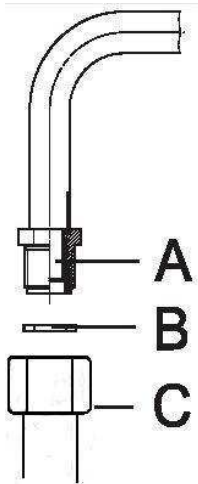

After connecting the gas hob, check the joints for any leaks.

Gas supply connection plug

A ISO7-1 R1/2 connection plug

B Non-metal gasket with thickness of 2 mm

C Pipe adapter for liquid gas (depending on the model)

Only use pipes and seals in accordance with the Standards. These pipes must be installed so that, when fully extended, their length does not exceed 2000 mm. For easier installation and to prevent gas leaks, attach the swivel coupling to the cook top first, and then to the gas mains pipe. Inverting this sequence may hamper the gas seal between the pipe and the cook top.

Important: when the installation is complete, check that all couplings are completely sealed by using a soapy solution. Never use a flame. Also ensure that the flexible pipe cannot come into contact with any moving part of the cook top (e.g. drawer) and that it is not in a position where it could be damaged.

After the connection, check the burners for correct operation.

The flames must be clearly visible, and should be blue and green at the center. If the flame is unstable, increase the minimum power.

Adaptation to a different type of gas

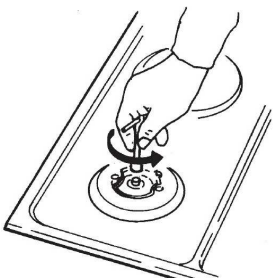

Adjustment elements

- The procedure or adaptation of the cooker to another type of gas does not require removal of the appliance from the worktop.
- Before adapting, disconnect the appliance from the power mains and close the gas supply valve.
- Replace the existing nozzles for nominal thermal load with corresponding nozzles for the new gas type and supplied provided (see table below).
- After finishing this sequence, replace the old setting label with the new one provided for the new injectors.

To leave the adjustment elements accessible, please observe the following instructions:

- Remove the support grid and burner covers with respective crowns.
- In double burners, adjustment elements are accessible behind the main nozzle protective plate.
- Remove the control knobs, including the gaskets.

Gas valve

Minimum thermal load regulation valve

Minimum flow adjustment

Instructions for urban (G110, G120, G150.1) and methane gas (G20, G25)

1. Light the burner and bring it to the minimum position.
2. Remove the gas tap knob and turn the adjustment screw on the side of the tap rod:
 - anti-clockwise to increase the gas flow
 - clockwise to reduce the gas flow

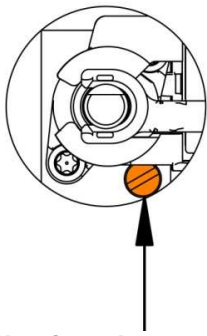

until a regular minimum flame is obtained.

3. Re-assemble the knob and verify burner flame stability (when quickly rotating the hand from maximum to minimum position the flame must not shut off).

4. Repeat the operation on all gas taps.

Instructions for liquid gas (LPG: G30, G31)

Tighten the screw on the side of the tap, rod clockwise completely.

Warning: these tasks may only be carried out by a qualified technician, authorized by the gas distributing company or authorized service center!

TECHNICAL INFORMATION (TABLE 1)

| | GKTG6SY2B | GKTG6SY2W |
|--------------------------|---|-----------|
| Appliance dimension (mm) | 585 | 585 |
| Operating voltage | 220-240 V~, 50/60 Hz | |
| Burner | A: Auxiliary burner (1,0kW) SR: Semirapid burner (1,75kW) MW: Bruciatore Mini-Wok (3,3kW) | |
| Front left | MW | MW |
| Rear left | SR | SR |
| Front central | - | - |
| Rear central | - | - |
| Front right | A | A |
| Rear right | SR | SR |
| Category Gas usage | G20 = 20mbar , G30 = 30mbar , G20 = 13mbar | |
| Total Power (W) | 7800 | 7800 |

NOZZLE TABLE

| Burner | | A | SR | MW |
|------------------------|------------------|----------|----------|----------|
| Rated heat output (kW) | | 1.00 | 1.75 | 3.30 |
| Ø INJECTOR (mm) | | | | |
| G30/G31 | 28..30/30-37mbar | 0.50 | 0.65 | 0.85 |
| G20 | 20mbar | 0.72 - X | 0.97 - Z | 1.28 - T |
| G20 | 13mbar | 0.84 | 1.03 | 1.45 |
| Ø BY-PASS (mm) | | | | |
| G30/G31 | 28..30/30-37mbar | 0.27 | 0.34 | 0.55 |
| G20 | 20mbar | REG. | REG. | REG. |
| G20 | 13mbar | REG. | REG. | REG. |

Important warnings

• The gas burners are fitted a candle as flame failure device. If the burner flame is extinguished accidentally or unintentionally (e.g. when some liquid boils over or when there is draught in the room):

- gas supply is automatically cut off, thus preventing the gas from being emitted into the room.

• Gas burner cover should always be placed on the burner crown very carefully. Make sure the slots on the burner crown are never obstructed.

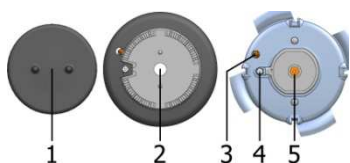

- 1 Burner crown cover
- 2 Burner crown with the support for the burner cover
- 3 Candle flame failure device
- 4 Ignition candle
- 5 Nozzle

Cookware

- Correctly selected cookware will enable optimum cooking time and gas consumption. Pan diameter is the most important parameter.
- Flames that reach over the edge of a pan that is too small, can damage the cookware; furthermore, gas consumption is higher in such cases.
- For combustion, the gas also needs air. If a pan is too large, air supply to the

burner is insufficient; as a result, combustion effect is lesser.



| Burner type | Pan diameter |
|---------------------|--------------|
| Auxiliary (1,0 kW) | 120 - 180 mm |
| Semirapid (1,75 kW) | 180 - 220 mm |
| Mini-Wok (3,3 kW) | 220 - 300 mm |

Important warnings regarding the glass ceramic hob

- Cooking zone reaches the selected power level or temperature very quickly; however, the area surrounding the cooking zones remains relatively cool.
 - The hob is resistant to temperature changes.
 - The hob is also impact-resistant. The pans may be placed onto the hob roughly without damaging the hob.
 - Glass ceramic hobs should not be used as a worktop. Sharp objects can cause scratches.
 - Preparing food in thin aluminum or plastic containers on hot cooking zones is not allowed. Do not place any plastic objects or aluminum foil on the glass ceramic hob.
 - Never use a glass-ceramic hob that is cracked or broken.
- If an object falls on the hob with a sharp edge downwards, this could cause the hob / glass ceramic panel to break. The consequences are visible immediately, or only after a while. If any visible crack should appear, immediately disconnect the appliance from the power supply.
- If sugar is spilt on a hot glass ceramic hob, or a sugar-laden food, immediately wipe the hob.

INSTRUCTIONS FOR USE AND MAINTENANCE

APPLIANCE DESCRIPTION

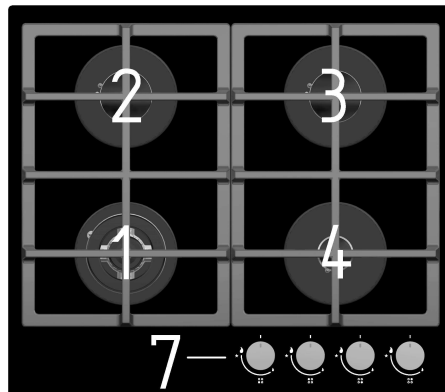

1. Gas cooking zone front left
2. Gas cooking zone rear left
3. Gas cooking zone rear right
4. Gas cooking zone front right
5. Gas cooking zone rear central
6. Gas cooking zone front central
7. Hob control panel

Hob control elements for gas cooking zones

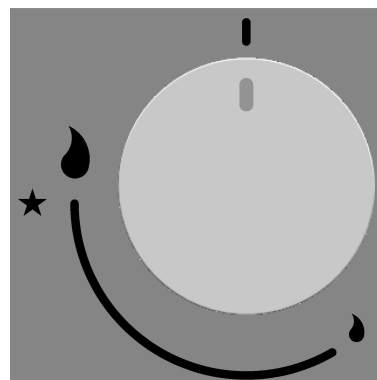

Gas valve closed



Ignition



Maximum power



Minimum power

Hob control elements for both left cooking zones



Cooking time function

For both left cooking zones the cooking time can be set. When the countdown cooking time expired the gas on selected burner is turned off. Cooking time can be set from 1 to 99 minutes.

Time function settings

- Turn on the gas cooking zone.
- Touch with finger the sensor key  on the knob for around 2 seconds. The number „-00+“ appear on display and also a short tone.
- By pressing the + and – key set the desired cooking time. At beginning the step is 1 minute and when pressing the longer time change to 10 minutes step. If the first press is on „-“, key then the value go on number „99“ and then decreases.
- When set the desirous time, after 5 seconds the „-“ and +“ disappears and countdown start.
- When the value drops to 00 then starts blinking and acoustic sound is appearing. Gas burner is shut down. Acoustic signal is switched off when you press any key or after one minute shuts of itself.

Change the setting value

Touch the sensor key  for around 2 seconds. On display appear „+ and –“. Now you can change the setting.

Early switch off the time

At early switch off the gas flow is not interrupted.

You can turn off in different ways:

- Set the setting by „-“, key to value „00“.
- or
- Simultaneously press the + and – buttons for around 2 seconds. Value moves to 00.
- By touching the sensor key  for 2 seconds, the setting erases.

WARNING: In case of electrical blackout, the timer turns off, but the flame is still on.

Ignition and operation of the burners

User's instructions

This appliance must be used for the purpose it was designed for, i.e. domestic cooking. Any other use is considered to be improper and therefore dangerous. The manufacturer will accept no liability for any damage caused by improper, incorrect or irrational use.

Using the burners

- If the burners are not used for several days, wait a few seconds before lighting them in order to release any air from the pipes.
- As the cook top burners are fitted with an automatic ignition, to light them simply press and turn the handle to the small star. The appliance uses a spark ignition generator.
- If the flame does not ignite within five seconds, turn the knob back to the 0 position and repeat the procedure; if the electric ignition should not work due to a power failure or damp spark plugs, the gas can also be ignited using a match or a gas lighter.
- For models with a safety tap (which interrupt the gas flow should the flame accidentally go out) the burners are ignited as described above, but ensure **the knob is pressed in for 5 to 6 seconds after the flame has ignited**. After this time, which gives the safety device enough time to cut-in, the flame will be on

permanently.

- The flame can then be set between the maximum and minimum level. Any setting between 0 and the large flame is not recommended, as the flame is not stable in this interval and may be extinguished.

WARNING: once the cook top has been cleaned, ensure that the burners are firmly in their seats and do not interfere with the igniter.

To get the best from the burners, use flat-bottomed pots with a diameter suited to the burner being used.

For smaller diameter pots and pans (coffee and tea pots, etc.), the power of the burner being used has to be regulated in order to ensure that the flame laps the bottom of the pot without spilling over. Do not use pots with concave or convex bottoms.

WARNING: if the burner flame is extinguished accidentally, turn off the knob and leave it for at least one minute before trying to re-ignite it.

- To extinguish the flame and close the burner gas supply, rotate the control knob to the 'OFF' position (0).

CAUTION: The gas cooking appliance use may cause heat, humidity and products of combustion in the room where is installed. Ensure that the kitchen is well ventilated especially when the appliance is in use: keep open any natural ventilation holes or install a mechanical ventilation device (mechanical extractor hood).

Prolonged intensive use of the appliance may call for additional ventilation, for example opening of a window, or more effective ventilation, for example increasing the level of mechanical ventilation where present.

CAUTION: Accessible parts may be hot when the hob is in use. Young children should be kept away.

CAUTION: This appliance is for cooking purposes only. It must not be used for other purposes, for example room heating.

CLEANING AND MAINTENANCE

Do not use a steam cleaning appliance to clean this appliance. The steam could reach the electrical components and cause a short circuit.

- The appliance should be cleaned regularly, preferably after each use, after cooling down.
- To avoid water marks and limescale deposits, use a soft cloth to dry surfaces that have been cleaned with water.
- Food that has boiled over can cause discolouration of the burner parts and the stainless steel cooktop. **Remove any soiling immediately.**

To avoid damaging the outer surfaces of your appliance, do not use:

- cleaning agents containing soda, alkalines, ammonia, acids or chlorides
- cleaning agents containing descaling agents
- stain or rust removers
- abrasive cleaning agents, e.g. powder cleaners and cream cleaners
- solvent-based cleaning agents
- dishwasher cleaner
- grill and oven cleaners
- glass cleaning agents
- hard, abrasive brushes or sponges, e.g. pot scourers, brushes or sponges which have been previously used with abrasive cleaning agents
- sharp pointed objects (these can damage the seal between the frame and the worktop).

Stainless steel surfaces

Clean stainless steel surfaces using a microfibre cloth or with a solution of warm water and a little washing-up liquid applied with a soft sponge. In the case of stubborn dried-on soiling, soak first.

Finally, dry with a soft cloth.

The stainless steel cooktop cleaner can be used to clean the frame when required. Apply with an even pressure following the direction of the "grain".

The care product for stainless steel can be used after cleaning to help keep your appliance looking good and to hinder resoiling.

Apply sparingly with a soft cloth following the instructions on the packaging.

Printed surfaces

The printing can be damaged if soiling (e.g. food or fluids that contained salt, olive oil) is not removed immediately.
Remove any soiling immediately.
Do not use any stainless steel cleaner on printed surfaces.
This would rub off the print.

Pan support and control knob

Do not clean the pan support in a dishwasher.
Remove the pan support. Clean the pan support and the control knob with a solution of warm water and a little washing-up liquid applied with a soft sponge. Stubborn soiling should be soaked first.
After cleaning, dry all surfaces with a clean cloth.

Burners

Do not clean any parts of the burner in a dishwasher.
The burner should be dismantled and then cleaned by hand using a solution of warm water and a little washing-up liquid applied with a soft sponge.
Parts of the burner that cannot be removed should be wiped clean with a damp cloth only.
The ignition candle and the candle flame failure device should be very carefully wiped clean using a well wrung out cloth.
Do not let the ignitor get wet. If it gets wet, it will not spark.
After cleaning, dry all surfaces with a clean cloth.
Make sure that the flame slits are clean and completely dry.
The surface of the burner crown cover will become more matt with time. This is quite normal and will not affect the operation of the cooktop.

Ceramic glass surface



Fig.1

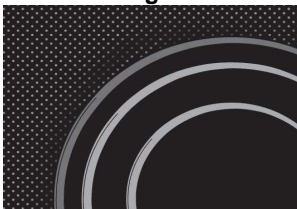

Fig.2



Fig.3



Fig.4

After each use of the glass-ceramic hob, wait for it to cool down and clean it; otherwise, even the smallest food residue will be burnt onto the hot surface next time you use the appliance.

For regular cleaning and maintenance of the glass-ceramic surface, use special conditioning agents which form a protective layer on the surface, shielding it from dirt.

Before each use, wipe any dust or other particles from the hob surface and pan bottom as these could scratch the surface (Figure 1).

Careful: steel wool, abrasive sponges, and abrasive detergents can scratch the hob surface. Glass ceramic surface can also be damaged by aggressive sprays and inappropriate or insufficiently shaken (mixed) liquid cleaning agents (Figure 1 and Figure 2).

Signs and indications on the hob may be worn if aggressive cleaning aids are used on cooking zone edges, or if pans with damaged bottom or used.
Light stains can be removed by a damp soft cloth; then, wipe the surface dry (Figure 3).

Water stains can be removed using a mild solution of vinegar however, do not use this solution to clean the frame (only with some models, as it may become dull. Do not use aggressive sprays or decalcification agents (Figure 3).
Heavier stains can be removed using special agents and utensils for cleaning the glass-ceramic hobs. When using these products, follow the instructions provided by their respective manufacturers.

Make sure any residues of cleaning agents are thoroughly removed, as they could damage the glass-ceramic hob when the cooking zones heat up (Figure 3).

Stubborn and burnt residues can be removed using a scraper.
make sure the plastic part of the scraper does not come into contact with a hot cooking zone. Be careful not to cut yourself with the scraper!
Sugar and sugar-laden food may permanently damage the glassceramic surface (Figure 5); therefore, they should be removed from the glass-ceramic surface as soon as possible, although the cooking zone may still be hot (Figure 4). Any change in the color of the glass-ceramic surface does not affect its operation

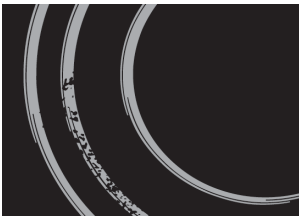

Fig.5

or the stability of the surface. Such discolorations are mostly a result of burnt food residues or use of cookware made of materials such as aluminum or copper; these stains are difficult to remove.

Warning: All damage described above predominantly relates to the aesthetics, i.e. appearance of the appliance and do not affect its functionality directly. Such errors cannot be the subject of a warranty claim.

SPECIAL WARNINGS AND FAULT REPORTING

Important

- During the warranty period, only a service center authorized by the manufacturer may carry out any repairs.
- Before making any repairs, make sure the appliance is disconnected from the power mains either by removing the fuse or by disconnecting the power plug from the wall outlet.
- Unauthorized tampering with and repairs of the kitchen range (cooking hob) can result in electric shock or short circuit; hence, do not attempt to perform any repairs by yourselves. Leave such tasks to an expert or an authorized service unit.
- In case of minor faults or problems with the appliance operation, check the following instructions to see whether you can eliminate the causes by yourselves.

A visit by a service technician during the warranty period will be charged if the appliance is not functioning because of improper use. Store these instructions in a place where they are always readily accessible; if pass the appliance on to another person, the instructions should also be included.

Following is some advice on rectifying some common problems.

| Problem | Possible cause | Elimination |
|--|--|--|
| The flame is uneven / unstable | Wrong gas power setting. | Have an expert check the gas pipeline! |
| The flame from the burners suddenly changes | Wrongly assembled parts of the kitchen hob | Assemble the burner correctly. |
| Burner ignition takes more time | Wrongly assembled parts of the kitchen hob | Assemble the burner correctly. |
| The flame is extinguished shortly after ignition | Knob pressed too short or too weakly. | Keep the knob depressed for a longer period of time. Before releasing it, press it harder. |
| The grid has discolored in the burner area | This is a commonplace phenomenon resulting from high temperature | Clean the grid with a metal care detergent. |
| Electric power supply in general is interrupted | The fuse may be blown | Check the fuse in the fuse box and replace it if it is blown |
| Electric ignition of the burners no longer works | There are food or detergent residues between the spark plug and the burner | Open and carefully clean the opening between the spark plug and the burner |
| If the burner cover looks unappealing | Regular dirt | Clean the burner covers with a metal care detergent. |

If the problem persists despite observing the instructions above, call an authorized service technician. Elimination of any errors or warranty claims that resulted from improper connection or use of the appliance is not covered by our warranty. In such cases, the costs of repair are borne by the user.

The Manufacturer strives for continuous improvements. For this reason, the text and illustrations in this book are subject to change without notice.

