

PRECAUTIONS	69	First use	84
General safety instructions	69	Using the oven	85
For this appliance	74	Using the temperature probe (on some models only)	88
Appliance purpose	75	Cooking advice	100
This user manual	75	Smart Cooking	105
Manufacturer's liability	75	Multistep cooking	106
Identification plate	76	History	106
Disposal	76	Mini guide to accessories	107
To save energy	76	Discover the recipes	107
Light sources	76	My recipes	107
How to read the user manual	76	Other functions	108
DESCRIPTION	77	In the event of a blackout	115
General Description	77	Settings	115
Control panel	77	CLEANING AND MAINTENANCE	119
Other parts	77	Cleaning the appliance	119
Accessories	78	Cleaning the oven cavity	120
Optional accessories (can be purchased separately)	79	Vapor Clean (on some models only)	121
Microwaves	80	Descaling	122
Advantages of humidified and steam cooking	80	Cleaning the reservoir and the water circuit manually	124
USE	80	Reservoir calibration	126
Preliminary operations	80	Extraordinary maintenance	127
Materials suitable for use with microwaves	81	INSTALLATION	127
Using the accessories	81	Electrical connection	127
Display	83	Positioning	128

We advise you to read this manual carefully, which contains all the instructions for maintaining the appliance's aesthetic and functional qualities. For further information on the product: www.smeg.com

PRECAUTIONS

IMPORTANT SAFETY INSTRUCTIONS

PLEASE READ CAREFULLY AND RETAIN FOR FUTURE USE

General safety instructions

Risk of personal injury

- **ATTENTION:** during use, the appliance and its accessible parts become very hot. Children must be kept away from the appliance.
- **ATTENTION:** during use, the appliance and its accessible parts become very hot. Never touch the heating elements during use.
- Protect your hands by wearing oven gloves when moving food inside the oven.
- Never try to put out a fire or flames with water: turn off the appliance and smother the flames with a fire blanket or other appropriate cover.
- This appliance may be used by

children aged at least 8 and by people of reduced physical, sensory or mental capacity, or lacking in experience in the use of electrical appliances, provided that they are supervised or instructed by adults who are responsible for their safety.

- Children must not play with the appliance.
- Keep children under the age of 8 at a safe distance unless they are constantly supervised.
- Keep children under the age of 8 away from the appliance when it is in use.
- Cleaning and maintenance must not be carried out by unsupervised children.
- The cooking process must always be monitored. A short cooking process must be continuously surveyed.
- Never leave the appliance unattended during cooking operations where fats or oils could be released, as these could then heat up and catch fire. Be very careful.
- Do not pour water directly onto very hot trays.
- Keep the oven door closed during cooking.
- If you need to move food or at the end of cooking, open the door 5 cm for a few seconds, let the steam come out, then open it fully.

- Do not insert pointed metal objects (cutlery or utensils) into the slots in the appliance.
- Switch off the appliance immediately after use.
- **DO NOT USE OR STORE FLAMMABLE MATERIALS NEAR THE APPLIANCE.**
- **DO NOT USE AEROSOLS IN THE VICINITY OF THIS APPLIANCE WHILST IT IS IN USE.**
- **DO NOT MODIFY THIS APPLIANCE.**
- Installation and servicing should be carried out by qualified personnel in accordance with current standards.
- Do not try to repair the appliance yourself or without the assistance of a qualified technician.
- Do not pull the cable to unplug the appliance.

For microwave appliances

- **WARNING:** If the door or the door seal is damaged, the appliance must not be used until it has been repaired by a qualified person.
- **WARNING:** It is hazardous for anyone other than a competent person to carry out any service or repair operation which involves the removal of a cover which offers protection against exposure to microwave energy.
- **WARNING:** Liquids and other

foods must not be heated in sealed containers since they are liable to explode.

- When a combined function is used, children should use the appliance only when supervised by an adult, as very high temperatures are generated.
- Check the appliance visually during the cooking of foods in plastic or paper containers.



**Improper use
Danger of explosion**

- To avoid these dangers, it is necessary to insert the supplied boiling rod (or a heat-resistant plastic spoon) in the container while heating.



**Improper use
Danger of explosion**

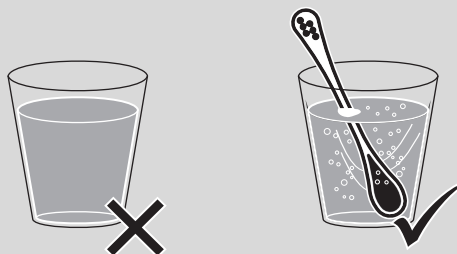

- When using the microwave to heat or reheat liquids, the boiling process may be delayed – boiling temperature can be reached without the formation of the usual "rolling boil".
- This delayed boiling and consequent superheating of the liquid can generate an explosion inside the appliance, or sudden boiling over of the superheated liquid can occur when removing the container from the appliance.

- Use the microwave only for the preparation of food for consumption. Other types of applications are strictly forbidden (e.g. drying clothes, warming slippers, sponges, wet cloths or the like, dehydrating foods) because they can lead to the risk of injury or fire.
- Microwave heating of beverages can cause delayed eruptive boiling, so care must be taken when handling the container.
- Clean the appliance constantly and remove any food residue.
- Failure to clean the oven cavity encourages deterioration of the surface, which could adversely affect the life of the appliance and possibly lead to a dangerous situation.
- Do not use the microwave to dry food.
- Do not use the microwave to heat oils or fry.
- Do not use the appliance to heat foods or beverages containing alcohol.
- Do not heat eggs in their shells or whole hard boiled eggs;

they may explode even after the heating process has completed.

- Do not heat food contained in food packages.
- Do not use the combination functions to heat or boil liquids.
- Baby food should not be heated in sealed containers. Remove the cover or the teat (in the case of baby bottles). Always check the temperature of the preparation after it has been heated, it should not be too high. For an even temperature and to avoid scalding stir or shake the contents.
- Puncture the skin of food that has a hard skin or peel (e.g. potatoes, apples, etc.) before cooking.
- Do not use the microwave functions when the oven is empty.
- Use kitchenware and utensils that are suitable for use in a microwave oven.
- Do not use aluminium containers to cook food.
- Do not use metal containers for cooking food or beverages.
- Do not use dishes with metallic decorations (gold-plated or silver).
- If present, do not use the tray and/or deep tray for microwave cooking **ONLY**.
- If smoke is present, switch off or

unplug the appliance from the power socket and keep the door closed to smother any flames.

- This appliance complies with the current standards and directives regarding safety and electromagnetic compatibility. However, it is recommended that people who wear pacemakers maintain a minimum distance of 20-30 cm between the pacemaker and the microwave oven when it is in operation. Contact the pacemaker manufacturer for further information.
- The appliance operates in the 2.4 GHz ISM band.
- In compliance with the provisions regarding electromagnetic compatibility, the appliance belongs to group 2 and class B (EN 55011).

 **Improper use**
Risk of damage to the appliance

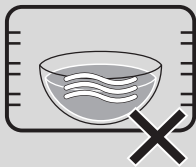

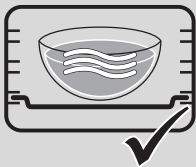

- When using the microwave, the food (or its container) must not be placed on the bottom of the oven cavity. Use the supplied accessories inserted in the shelves suitable for the recipe you want to make.



Improper use
Risk of damage to the appliance

- DO NOT USE CONTAINERS/ ACCESSORIES (trays, glass dishes, etc.) RESTING DIRECTLY ON THE BOTTOM OF THE OVEN CAVITY.

- If the appliance is installed in a cabinet, it must be operated with any cabinet door open.

Risk of damaging the appliance

- Do not use abrasive or corrosive detergents (e.g. scouring powders, stain removers and metallic sponges), rough or abrasive materials or sharp metal scrapers on glass parts as this could cause scratch the surface and break the glass. Use wooden or plastic utensils.
- Do not sit on the appliance.
- Do not use cleaning products containing chlorine, ammonia or bleach on parts made of steel or that have metallic surface finishes (e.g. anodizing, nickel- or chromium-plating).
- Racks and trays should be inserted as far as they will go into the side guides. The mechanical safety locks that prevent them from being removed must face downwards and towards the back of the

oven cavity.

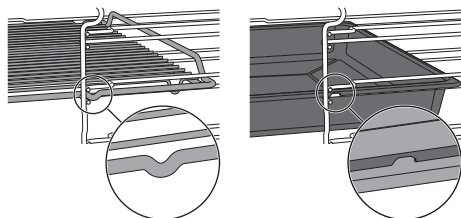

- Do not use steam jets to clean the appliance.
- Do not spray any spray product near the appliance.
- Do not obstruct ventilation openings and heat dispersal slots.
- Fire hazard: never leave objects in the oven cavity.
- DO NOT FOR ANY REASON USE THE APPLIANCE AS A SPACE HEATER.
- Do not use plastic cookware or containers when cooking food.
- Do not place sealed tins or containers in the oven cavity.
- Remove all trays and racks which are not required during cooking.
- Do not cover the bottom of the oven cavity with aluminium or tin foil sheets.
- Do not place pans or trays directly on the bottom of the oven cavity.
- If necessary, you can use the tray rack (supplied or sold separately, depending on the model) by placing it on the bottom as a support for cooking.
- If you wish to use greaseproof

paper, place it so that it will not interfere with the hot air circulation inside the oven cavity.

- Do not use the open door to rest pans or trays on the internal glass pane.
- Never use the oven door to lever the appliance into place when fitting.
- Avoid exerting too much pressure on the door when open.
- Do not use the handle to lift or move this appliance.

Installation and maintenance

- THIS APPLIANCE **MUST NOT BE INSTALLED** IN A BOAT OR CARAVAN.
- The appliance must not be installed on a pedestal.
- Position the appliance into the cabinet cut-out with the help of a second person.
- To prevent any possible overheating, the appliance should not be installed behind a decoration door or a panel.
- Installation and servicing should be carried out by qualified personnel in accordance with current standards.
- Have the electrical connection performed by authorised technical personnel.
- The appliance must be connected to ground in compliance with electrical

system safety standards.

- Use cables withstanding a temperature of at least 90 °C.
- The tightening torque of the screws of the terminal supply wires must be 1.5 - 2 Nm.
- If the power cable becomes damaged, contact technical support immediately to arrange for it to be replaced in order to avoid possible hazards.
- Always use any necessary/required personal protective equipment (PPE) before performing any work on the appliance (installation, maintenance, positioning or movement).
- Before performing any operation on the appliance, switch off the power supply.
- Disconnect the appliance after the installation, through an accessible plug or switch in case of fixed connection.
- Fit the power line with an all-pole circuit breaker with a contact separation distance sufficient to provide complete disconnection in category III overvoltage conditions, pursuant to installation regulations.
- This appliance can be used up to a maximum altitude of 4,000 metres above sea level.

For this appliance

- Do not rest any weight or sit on the open door of the

- appliance.
- Take care that no objects are stuck in the doors.
- Do not install/use the appliance outdoors.
- (on some models only) Only use the temperature probe provided or recommended by the manufacturer.

Temperature probe (if present)

- Do not touch the rod or the tip of the temperature probe after use.
- Wear oven gloves when handling the temperature probe.
- Take care not to scratch or damage enamelled or chrome-plated surfaces with the tip or the plug of the temperature probe.
- Do not insert the temperature probe into openings and slots on the appliance.
- When the temperature probe is not in use, make sure that the protective metal cap is properly closed.
- Do not pull the cable to remove the temperature probe from the socket or from the food.
- Make sure that the temperature probe or its cable do not get caught in the door.
- Make sure that the temperature probe or its cable do not come into contact with heating elements inside the oven.

- No part of the temperature probe should be allowed to come into contact with the walls of the oven cavity, the heating elements, the racks or the trays when they are still hot.
- The probe should not be kept inside the appliance.
- Do not use the temperature probe during the pyrolytic cycle.

Appliance purpose

This appliance is intended for cooking food in the home environment. Every other use is considered inappropriate. It cannot be used:

- in employee kitchens, shops, offices and other working environments.
- in farms/farmhouses.
- by guests in hotels, motels and residential environments.
- In bed and breakfast accommodation.

This user manual

- This user manual is an integral part of the appliance and must therefore be kept in its entirety and within the user's reach for the whole working life of the appliance.
- Read this user manual carefully before using the appliance.
- The explanations in this manual include images, which describe all that regularly appears on the display. However, it should be kept in mind that the appliance may be equipped with an updated version of the system, and as such, all that appears on the display may differ from those in the manual.

Manufacturer's liability

The manufacturer declines all liability for damage to persons or property caused by:

- use of the appliance other than that specified;
- failure to comply with the instructions in the user manual;
- tampering with any part of the appliance;
- use of non-original spare parts.

Identification plate

The identification plate bears the technical data, serial number and brand name of the appliance. Do not remove the identification plate for any reason.

Disposal



This appliance conforms to the WEEE European directive (2012/19/EU) and must be disposed of separately from other waste at the end of its service life.

The appliance does not contain substances in quantities sufficient to be considered hazardous to health and the environment, in accordance with current European directives.



Power voltage Danger of electrocution

- Disconnect the mains power supply.
- Unplug the appliance.

To dispose of the appliance:

- Cut the power cable and remove it.
- Deliver the appliance to the appropriate recycling centre for electrical and electronic equipment waste, or return it to the retailer when purchasing an equivalent product, on a one for one basis.

Our appliances are packaged in non-polluting and recyclable materials.

- Deliver the packing materials to the appropriate recycling centre.



Plastic packaging Danger of suffocation

- Do not leave the packaging or any part of it unattended.
- Do not let children play with the plastic bags.

To save energy

- Only preheat the appliance if the recipe requires you to do so. The preheating stage can be disabled for all functions (see chapter "Preheating") apart from the PIZZA

(preheating cannot be disabled) and ECO functions (no preheating stage).

- When using the functions (including the ECO function), avoid opening the door during cooking.
- Unless otherwise indicated on the package, defrost frozen foods before placing them in the oven.
- When cooking several types of food it is recommended to cook the foods one after the other to make the best use of the already hot oven.
- Use dark metal moulds: They help to absorb the heat better.
- Remove all trays and racks which are not required during cooking.
- Stop cooking a few minutes before the time normally used. Cooking will continue for the remaining minutes with the heat which has accumulated inside the oven.
- Reduce any opening of the door to a minimum to avoid heat dispersal.
- Keep the inside of the oven clean at all times.

Light sources

- This appliance contains light sources which cannot be replaced by the user and must only be replaced by the technical assistance service.

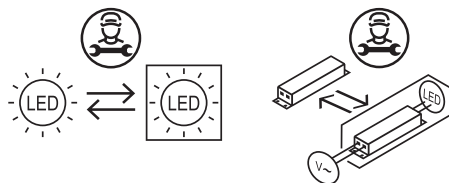

- This appliance contains light sources of efficiency class "E".

How to read the user manual

This user manual uses the following reading conventions:



Warning/ Caution



Information/ Advice

DESCRIPTION

General Description

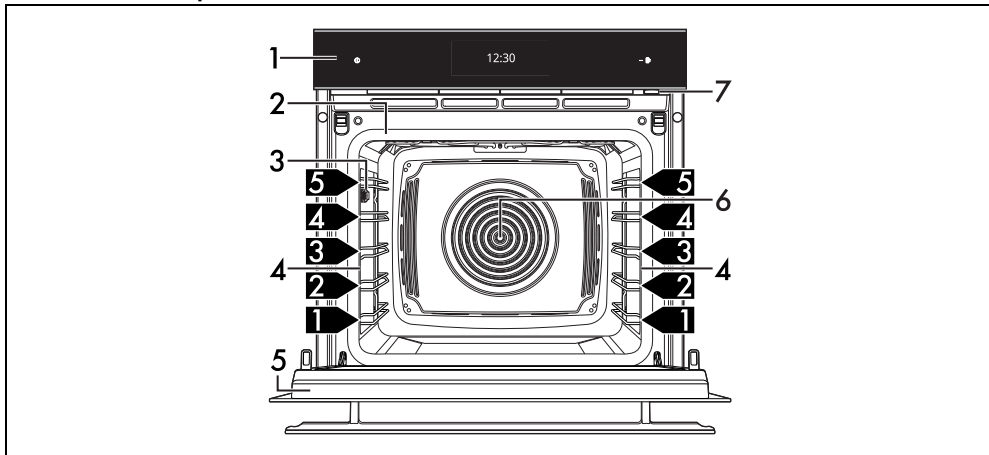

- 1 Control panel
- 2 Seal
- 3 Temperature probe socket (on some models only)
- 4 Light bulb
- 5 Door
- 6 Fan
- 7 Loading wand
- 1,2,3 Frame shelf

Control panel

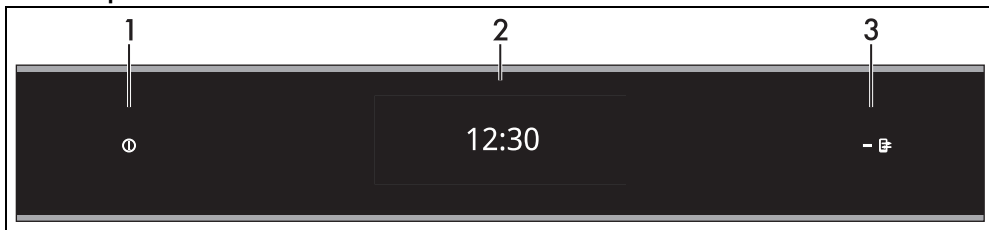

1 ON/OFF key

The ON/OFF button turns the appliance on or off.

2 Display

The touchscreen display allows you to interact with the appliance. Touch the icons to access the various functions. All the operating parameters will be shown on the display.

3 Remote control indicator light (on some models only)

When lit it indicates that the appliance can be controlled remotely via a smartphone or tablet (see the "Built-in oven connectivity" user manual).

SmegConnect (on some models only)

The appliance is equipped with SmegConnect technology that allows the user to control the appliance operation via an App on their smartphone or tablet.

For further information, refer to the supplied brochure and/or visit the site www.smeg.com

Other parts

Shelves

The appliance features shelves to position trays and racks at different heights. The insertion heights are indicated from the bottom upwards.

Cooling fan

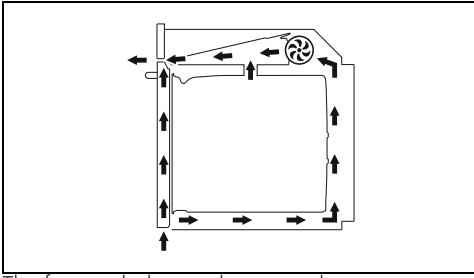

The fan cools the appliance and comes into operation during cooking. The fan causes a steady outflow of air from above the door which may continue for a short period of time even after the appliance has been turned off.

Oven cavity lighting

The appliance's interior lighting comes on:

- when the door is opened;
- during one function, touch the light symbol 

to manually activate or deactivate the oven cavity light, apart from the  and



functions.



In order to save energy, the light turns off after about one minute from the start of cooking or whenever the door is opened (this function can be disabled via the secondary menu).

Accessories

- Not all accessories are available on some models.
- The accessories intended to come into contact with food are made of materials that comply with the provisions of current legislation.
- Original supplied and optional accessories can be requested to Authorised Assistance Centres. Use only original accessories supplied by the manufacturer.

Boiling rod

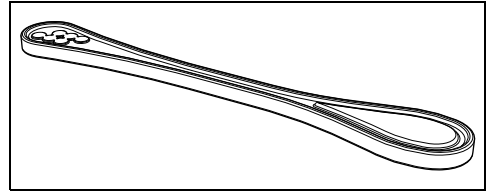

To be placed in containers when heating liquids, necessary to avoid delayed boiling.

Glass dish

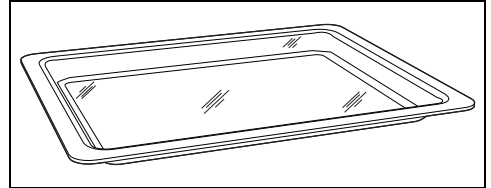

Useful for any type of cooking and collecting fat from foods placed on the rack above. To be placed on top of the lowered pan stand, it is particularly suitable for microwave cooking.

Perforated tray

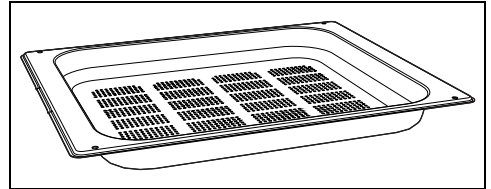

Useful for steaming fish and vegetables.

Steel baking tray

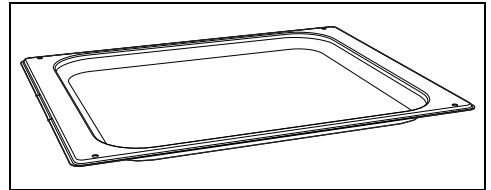

Useful when cooking cakes (with cooking times of less than 25 minutes or without steam), rice, beans and cereals. It is also essential for collecting liquids produced by steaming or defrosting foods contained in the perforated tray above.

Rack

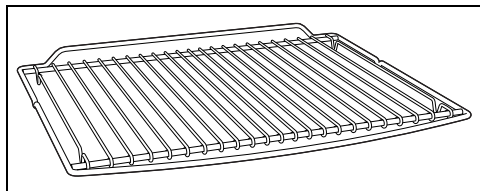

Used for supporting containers with food during cooking.

Tray rack

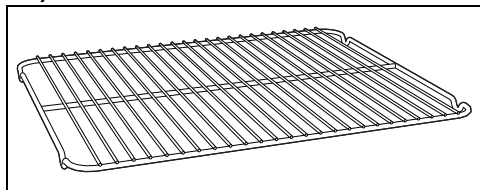

To be placed over the top of the tray; for cooking foods which may drip.

Deep tray

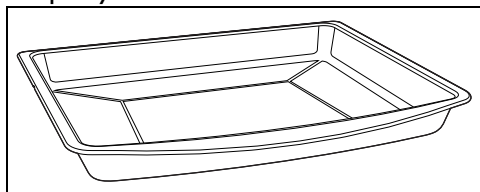

Useful for collecting fat from foods placed on the rack above and for cooking pies, pizzas, baked desserts, biscuits, etc.



WARNING: The deep tray can be used for combined microwave cooking. Do not use it for microwave cooking **ONLY**.

Protective cover (on some models only)

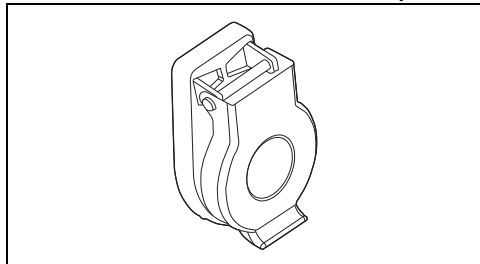

Used to cover and protect the temperature probe socket when the temperature probe is not in use.

Temperature probe (on some models only)

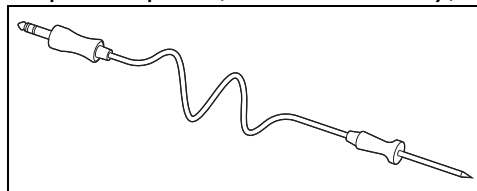

With the temperature probe, you can cook according to the temperature measured at the centre the food.

Optional accessories (can be purchased separately)

Jug

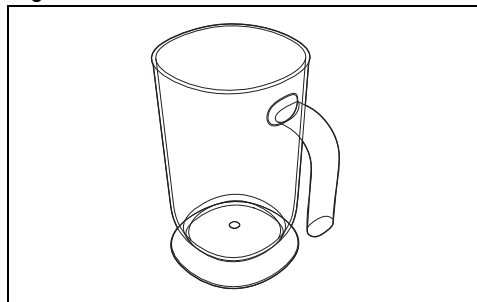

Useful for containing liquids during filling and emptying of the reservoir.

PPR2 or STONE (refractory stone)

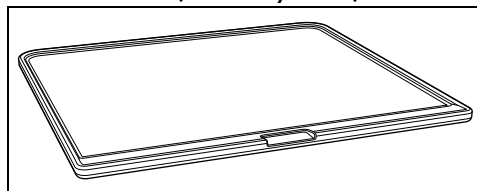

Ideal accessory for baking bread (pizza, bread, focaccia...), but you can also use it for more delicate preparations such as biscuits.

BBQ (teflon-coated barbecue grill pan)

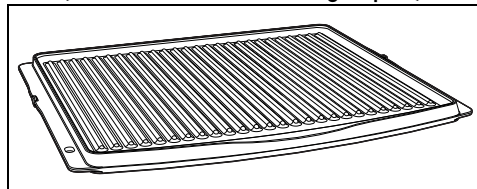

Double-use accessory: the striped side is recommended for grilling meat (fillets, hamburgers...), while the smooth surface can be used for cooking vegetables, fruit, fish...

AIRFRY (oil-free frying grill)

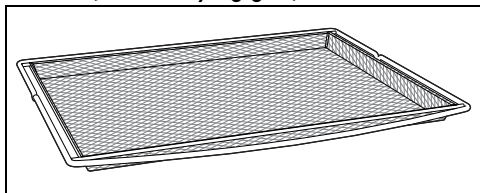

Recommended accessory for air-frying previously breaded, precooked and/or frozen food (chips, potato or meat croquettes, small mozzarella bites...).

Microwaves

The appliance is equipped with a microwave generator called a magnetron. The microwaves generated are evenly emitted into the oven cavity in order to reach the food and heat it.

Heating takes place through friction between the molecules contained in the food (mainly water molecules), with the consequent generation of heat.

The heat generated directly inside the food allows it to be defrosted, re-heated or cooked in a shorter time compared to traditional cooking.

The use of suitable containers for microwave cooking leads to the microwaves reaching the food in a uniform manner.

Advantages of humidified and steam cooking

The steam cooking system cooks any type of food much smoother and faster and finds its main applications for:

- Braising and stewing
- Cooking sauces
- Cooking au gratin
- Roasting
- Low temperature cooking
- Regenerating

USE

Preliminary operations



See General safety instructions.

- Remove any protective film from the outside or inside of the appliance, including accessories.

- Multi-mode cooking

Variations in temperature and steam levels allow the wished gastronomic result to be achieved.

The addition of steam allows the use of less fat in favour of a healthier and more genuine cuisine. It also minimizes the loss of weight and volume in food while cooking.

Steam cooking is particularly suitable for cooking meat: in addition to making it very soft, it maintains it bright and makes it more succulent.

Also recommended for baking leavened and bread dough. The humidity in fact lets the dough grow and develop while cooking before creating the outer crust. The result is a lighter and more digestible dough, recognizable by thicker pockets.

(Valid for steam cooking only)

It is also ideal for defrosting food rapidly, for heating up foods without hardening or drying them out, and for naturally removing salt from foodstuffs preserved with salt.

It is not recommended for short cooking times or for foods that may produce a large amount of moisture during cooking.

Cooking containers

- You may also use your own containers for cooking, as long as they are resistant to high temperatures.
- For steam cooking, the use of metal containers is recommended. Metal facilitates better distribution of heat to the foods.
- It is normal for metal containers to deform somewhat during high-temperature cooking, but they will return to their original shape when they cool down.
- Thick ceramic plates may require more heat than normal. Longer cooking times may be necessary.

- Remove any labels (apart from the technical data plate) from the accessories and shelves.
- Remove and wash all the appliance accessories (see chapter "CLEANING AND MAINTENANCE").

First heating

1. Set a cooking time of at least one hour (see paragraph "Using the oven").
2. Heat the empty oven compartment at the maximum temperature to burn off any residues left by the manufacturing process.

When heating the appliance

- air the room;
- don't stay.

Materials suitable for use with microwaves

In general, in order for all of the food to be reached, the materials used for microwave cooking must be transparent to microwave energy.

Below is a table of materials to use and those not to use:

MATERIALS TO USE:

- Glass (always remove the lids) *
- Baking ware
- Glasses
- Jars
- Porcelain
- Earthenware
- Plastic (only where suitable for microwave use) *
- Containers
- Plastic wrap (must not come into contact with the food)

* only if heat-resistant.

MATERIALS NOT TO USE

- Metals (can lead to arcing or sparks)
- Aluminium foil
- Aluminium trays
- Plates
- Metal utensils
- Freezer bags tie wraps
- Wood
- Crystal glasses
- Paper (risk of fire)
- Polystyrene containers (danger of contamination of foodstuffs)



Dishes must be free of metal decorations.



Do not use metal accessory trays in the microwave or combined microwave functions.

Testing dishes



The microwave function can be used without any food inside the oven only for this test.

To check whether the cookware is suitable for use with microwave cooking, carry out this simple test:

1. Remove all accessories from the oven cavity.
2. Place the cookware to be tested on the rack inserted in the first shelf.
3. Select the microwave function at maximum power level (e.g. 1000 W).
4. Set a cooking time of 30 seconds.
5. Start cooking.



Unsuitable cookware
Risk of damage to the appliance

- Stop the test immediately if there is a cracking sound or if sparks are emitted from the cookware. If this happens, it means that the cookware is not suitable for microwave cooking.

At the end of the test the cookware must be either cold or slightly warm. If the cookware is hot then it should be considered as unsuitable for microwave use.

Using the accessories

Racks and trays

Racks and trays have to be inserted into the side guides until they come to a complete stop.

- The mechanical safety locks that prevent the rack from being removed accidentally must face downwards and towards the back of the oven cavity.

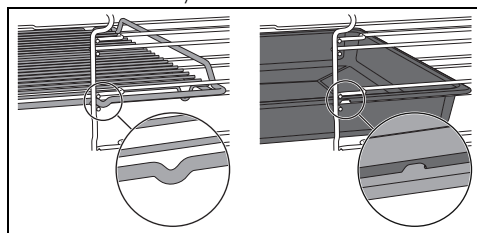

Gently insert racks and trays into the oven until they come to a stop.



Clean the trays before using them for the first time to remove any residues left by the manufacturing process.

Tray rack

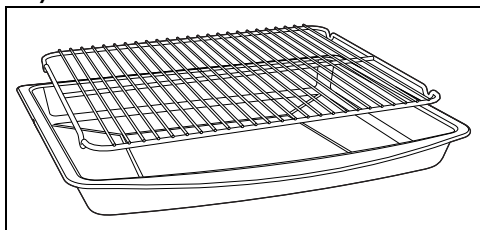

The tray rack has to be inserted into the tray. In this way fat can be collected separately from the food which is being cooked.

Configuration for steam cooking

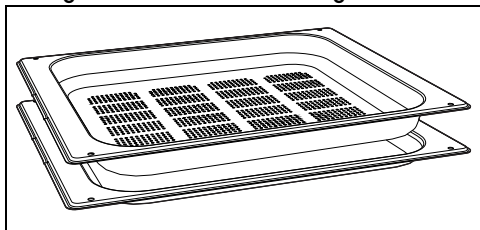

If you intend to use the perforated baking tray for steam cooking, it must be placed on the desired shelf taking care to place the steel baking tray on the shelf below. This allows liquids to be collected separately from the food which is being cooked.

Boiling rod



Improper use
Danger of explosion/burns

- To avoid the danger of explosion inside the appliance or the sudden boiling over of superheated liquids, always place a boiling rod in the liquid that is being heated.



High temperature
Risk of damage to the accessory

- Use the boiling rod only with Microwave functions. The rod must not be used with combination and traditional functions.

When using the microwave to heat or reheat liquids, the boiling process may be delayed. To avoid this, place the boiling rod (or a heat-resistant plastic spoon) supplied into the

container while heating.

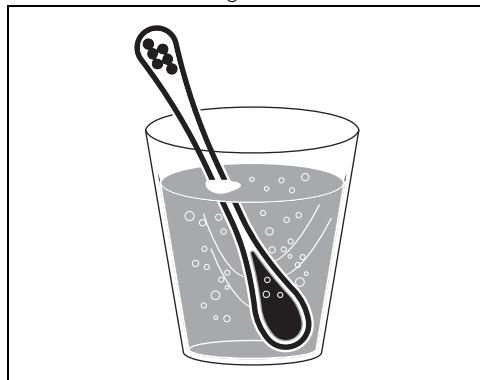

Rack and glass tray

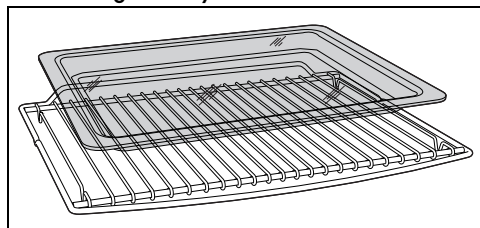

The glass tray must be placed on the rack. The tray rack has to be inserted into the glass tray. In this way fat can be collected separately from the food which is being cooked.

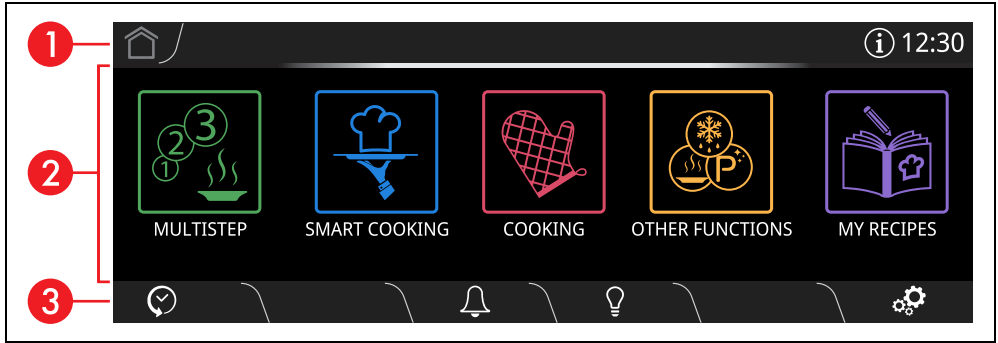



The parameters and values for the currently selected function will be indicated on the display. To use it, simply touch the "virtual" keys and/or scroll through the values indicated (the image shows the main menu screen).



1 Information area

Information regarding the menus and submenus of the functions in progress in the main area are indicated in this area.

The following are also present in this area:

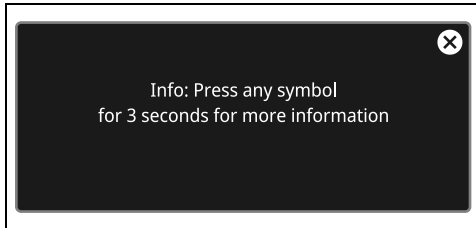
- HOME  button: touch this button to return to the main menu;
- INFORMATION  button: touch this button to display the following screen:



The INFORMATION button  is replaced by the symbol  to warn that the door is open.

- current time display.

2 Main area

The various functions of the appliance can be set in this area. Touch the buttons and values to set the required function.

In addition, depending on the screen, dots may appear at the bottom of this area to indicate that there are other function pages, which can be reached by scrolling horizontally.



3 Lower area



There are various shortcut function buttons in this area, which vary according to the functions set in the main area:

-  HISTORY
-  TIMER
-  LIGHT BULB
-  SETTINGS

In addition, depending on the page displayed, there are other buttons, some of which are listed below:

-  BACK
-  CONFIRM
-  START
-  REPLAY
-  STOP
-  SAVE
-  DELETE
-  RAPID PRE-HEATING

 PROBE (on some models only)

 Press and hold the HOME  button or the ON-OFF  button for a few seconds to stop cooking immediately at any time and return to the main menu.

Connectivity (on some models only)

Connectivity requirements:

- Smartphone or PC tablet with IOS or Android operating system. The minimum versions of the operating systems are available at the following link:

www.smeg.com/smegconnect/

- Wi-Fi network (2.4 GHz band, WPA2 protected) active and available in the place where the appliance is installed.
- Internet connection.
- Name and password of the home Wi-Fi network or WPS (Wi-Fi Protected Setup) mode available.

For further information, please refer to the "Built-in oven connectivity" manual.

First use

 The following instructions are also valid in the case of a prolonged power failure.

To switch on the appliance:

1. Connect the appliance to the mains power supply.

The manufacturer's logo will display for a few seconds.

 After the appliance is switched on, you will need to wait a few seconds before you can use it.



The display then shows the current time setting screen.

To be able to start any cooking function, the current time must be set.

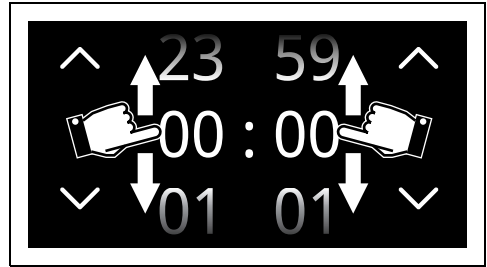
2. Scroll up and down through the hours and minutes to set the current time.







3. Touch the CONFIRM  button (at the right in the lower area ) to set the current time.



 To change the current time (e.g. due to daylight saving time) touch the time shown on the display (in the information area ) on the right).

 When the current time is visible, after 2 minutes from the last operation by the user it is displayed with low brightness.

The first time you use the appliance, it may be set to a language other than the one you speak. It is recommended that you set the required language at this point.

4. Touch the SETTINGS  button on the display (at the right in the lower area ) .
5. Touch the display button  .
6. In the Language  option (on the left), scroll through the available languages (on the right) to select the required language.
7. Touch the CONFIRM  button.

Deactivating the display

 When the  "Show the time" mode is set to Off, if the time display is shown, the display will switch off automatically after 2 minutes.

To deactivate the display manually:

- Press and hold the ON-OFF  button for a few seconds until you hear a

sound.

Reactivating the display



To reactivate the display when it is off:

- Press and hold the ON-OFF  button for a few seconds until you hear a series of sounds.

The display turns on after a few seconds. The display shows the main menu when it is switched on again.



In some cases, the ON-OFF  button does not deactivate the display. For example, when:

- there is a cooking function in progress (the button stops the function);
- the door is open;
- a minute minder timer is active;
- the  Showroom and/or  Demo modes are active.

Using the oven



See General safety instructions.

Traditional cooking



Each time the door is opened, the function in progress will stop and then automatically restart when the door is closed again.

1. Touch the time indicated on the display.



2. Touch the COOKING  button on the "main menu" (in the main area ).

3. Touch the TRADITIONAL COOKING

MENU  button.

4. Select a combination function (for example FAN-HEATED ) to enter the relevant cooking screen.

5. Touch the START  button (at the lower right ) to start pre-heating.

Preheating stage

Cooking itself is preceded by a preheating stage, which allows the appliance to heat to the cooking temperature more quickly.

This stage is indicated by a progressive increase in the temperature level reached.



Unless otherwise indicated in the recipe, it is not recommended to place food in the oven during the preheating stage.



You can skip the pre-heating phase by pressing the button  related.

After pre-heating, a buzzer will sound and a message will display to indicate that the food can be put in the oven.

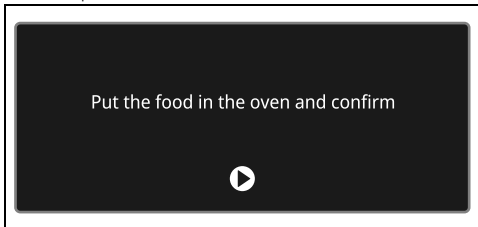

Cooking phase

1. Open the door
2. Place the dish with the food to be cooked into the oven cavity.
3. Close the door.
4. Touch the START  button to start cooking.

This stage is indicated by a progressive increase

in the cooking level.



Modifying the cooking temperature



The temperature can be modified at any time during cooking.

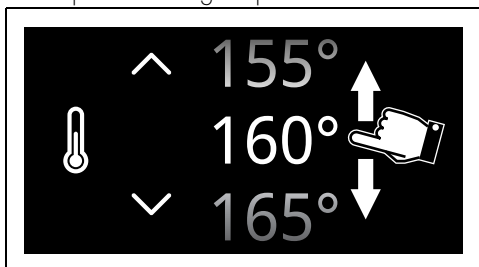

1. Touch the TEMPERATURE  button or the relevant value.
2. Scroll through the values and select the required cooking temperature.



3. Touch the CONFIRM  button (at the lower right **3**) to confirm the cooking temperature that has been selected.

End of cooking

To end cooking at any time:

1. touch the STOP button .
2. Touch the CONFIRM  button.

Timed cooking



Timed cooking is the function which allows a cooking operation to be started and then ended after a specific length of time set by the user.

1. After selecting a function, touch the COOKING DURATION  button or the relative value.

2. Scroll through the values and select the required duration.

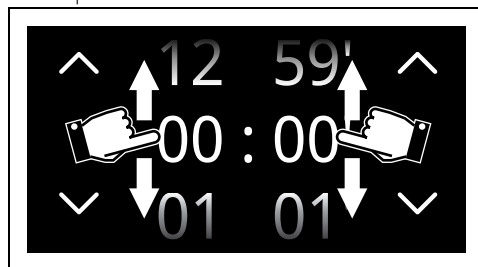

3. Touch the CONFIRM  button to confirm the selected cooking duration.



The hours and minutes can be selected separately.



The duration of the timed cooking function can be from a minimum of 1 minute to a maximum of 12 hours and 59 minutes.

The expected end of cooking time appears under the duration.



The minutes required for pre-heating are already included in the end-of-cooking time.



The countdown starts after the pre-heating has ended or if you wish to avoid pre-heating (touch the relative button .

4. Touch the START  button to start timed cooking.

End of cooking

At the end of cooking, "Function ended" displays and a buzzer sounds briefly, which can be deactivated by touching any point of the display or by opening the door.

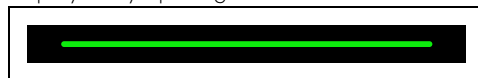

- Touch the HOME  button to quit the function.

Programmed cooking



Programmed cooking is the function which allows a time-controlled cooking operation to be stopped at an established time depending on the time set by the user, after which the appliance will switch off automatically.



For safety reasons, it is not possible to set the end of cooking time by itself without setting the cooking duration.

1. After setting timed cooking, touch PROGRAMMED COOKING  button or the relevant value.
2. Scroll through the values and select the required end-of-cooking time.

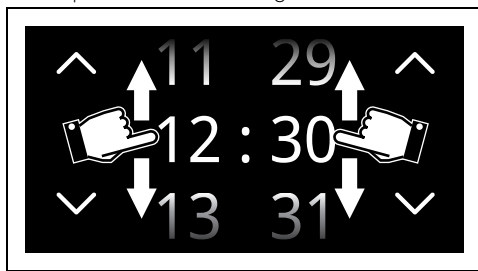

The hours and minutes can be selected separately.

3. Touch the CONFIRM  button to confirm the selected end of cooking time.

End of cooking

At the end of cooking, "Function ended" displays and a buzzer sounds briefly, which can be deactivated by touching any point of the display or by opening the door.



- Touch the HOME  button to quit the function.

List of traditional cooking functions



Not all functions are available on some models.

STATIC



Traditional cooking suitable for the preparation of one dish at a time. Ideal for cooking roasts, fatty meats, bread, pies.

FAN-ASSISTED



Intense and uniform cooking. Ideal for biscuits, cakes and multilevel cooking.

THERMALLY-VENTILATED



The heat is distributed quickly and evenly. Suitable for all dishes, ideal for cooking on several levels without mixing odours and flavours.

TURBO



Allows quick cooking on multiple shelves without mixing the aromas. Perfect for large volumes that call for intense cooking.

GRILL



It allows to obtain excellent grilling and grating results. Used at the end of cooking, it gives a uniform browning to the dishes.

FAN-ASSISTED GRILL



Allows optimal grilling of even the thickest meats. Perfect for large cuts of meat.

BASE



The heat only comes from the bottom of the cavity. Perfect for cakes, pies, tarts and pizzas.

THERMALLY-VENTILATED BASE



Allows you to quickly finish cooking food already cooked on the surface but not internally. Perfect for any quiches and any type of food.

PIZZA



Function designed for cooking pizza. Perfect not just for pizzas, but also for biscuits and cakes.

ECO



This function is particularly suitable for cooking on a single shelf with low energy consumption. It is recommended for all types of food, excluding those that can create a lot of humidity (such as vegetables). To obtain maximum energy savings and reduce cooking times, it is recommended to place food in the oven without preheating.



When using the ECO function, avoid opening the door during cooking.



In the ECO function cooking times (and any preheating) are longer and may depend on the amount of food in the cooking compartment.



The ECO function is a delicate cooking function and is recommended for food withstanding temperatures lower than 210°C; in case of cooking at higher temperatures, select another function.

Minute minder timer





This function only activates the buzzer, without stopping the function in progress.



The Timer can be set from a minimum of 1 minute to a maximum of 12 hours and 59 minutes.

1. Touch the **TIMER**  button (in the lower area ) to access the Timer menu.

Up to 3 minute minder Timers can be set:

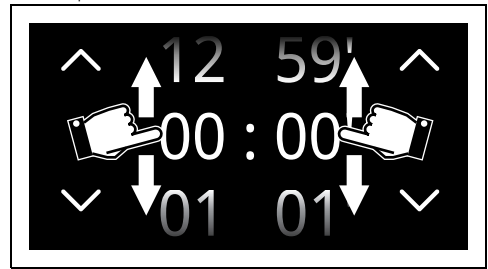

2. Touch the button of the **TIMER**  -  - ³ that you intend to use.

3. Scroll through the values and select the required duration.



4. Touch the **CONFIRM**  button to confirm the selected duration.



The **DELETE**  button appears in the lower area  that can be used to delete a timer if one has been selected.

5. Repeat the procedure for the other Timers that you intend to use.

6. When finished, touch the **CONFIRM**  button again to confirm the selected timers.





To cancel the operation, touch the **RETURN**  button.



The counter must be set to zero in order to remove the minute minder timer.



The display cannot be switched off using the **ON-OFF**  button when a timer is active.

In the following display, the lit **TIMER**  button indicates that one or more minute minder timers have been activated.

7. Wait for the buzzer to indicate that the time has finished.

Using the temperature probe (on some models only)



See General safety instructions.

The temperature probe enables you to cook roasts, loin steaks and other cuts and sizes of meat with great precision. The probe ensures that the food is perfectly cooked by monitoring the core temperature of the food. The core

temperature is measured by a sensor inside the tip of the probe.



Do not install any telescopic guides on the fourth shelf from the bottom, as they would not allow access to the temperature probe side socket.

Positioning the probe

1. Place the food on a tray.
2. Insert the tip of the probe into the food before you place it in the oven.
3. For best results, make sure that the temperature probe is placed transversely in the thickest part of the food and for least 3/4 of its length. Make sure that it does not touch the tray underneath and that it does not protrude from the food.

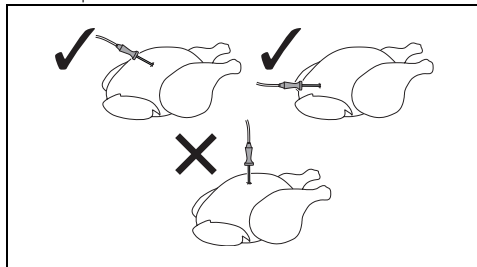

4. The 3 notches on the temperature probe must be inserted into the food.

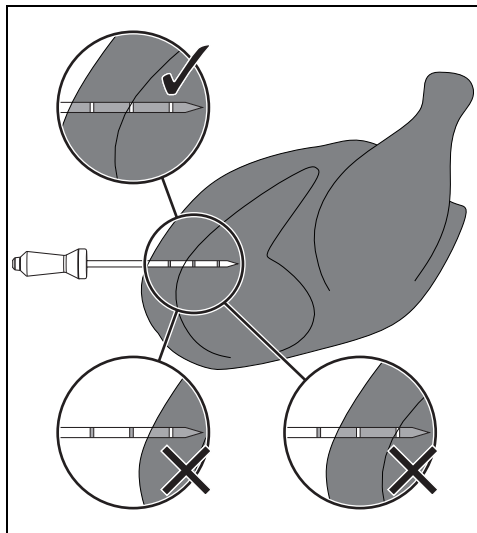

In order for the probe to measure the core temperature of the food precisely, its tip must not be in contact with bones or fat.





The recommended minimum temperature for cooking with the probe is 120°C, with the exception of slow temperature cooking.



If the probe does not read the temperature of the food correctly, 2 error messages will appear on the display (to acknowledge), after which, the appliance will automatically carry out timed cooking.

Setting cooking parameters when using the temperature probe

1. Select a cooking function.
2. Touch the TEMPERATURE  button or the relevant value.
3. Scroll through the values and select the required cooking temperature.
4. Touch the CONFIRM  button.
5. Touch the PROBE  button in the lower area **3**.
6. Scroll through the target temperature values and select the required temperature.

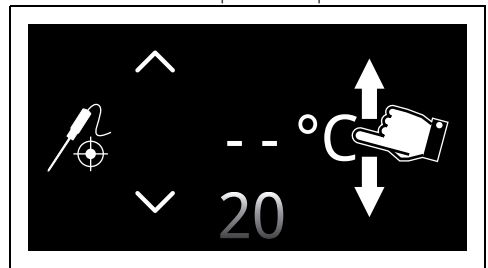

The temperature range that can be selected is from a minimum of 20°C to a maximum of 90°C.



If the temperature of the oven is set too low, the appliance automatically sets the minimum temperature necessary in order to reach the selected target temperature.



For best results, it is recommended to set a cooking temperature higher than the target temperature.

7. Touch the CONFIRM  button to confirm the selected probe temperature.

A message appears on the display to remind you to connect the probe to the socket and to place it in the food.

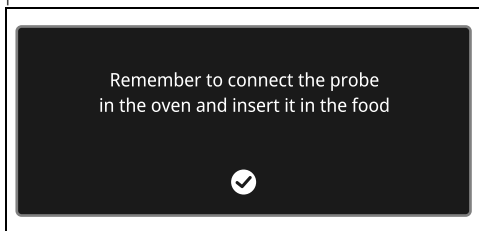



8. Touch the CONFIRM  button.

Cooking Δt



The appliance automatically sets the cavity temperature to a predefined temperature (called Δt) which is higher than the core temperature detected by the probe. When the probe detects one degree more at the core, the appliance automatically increases its internal temperature by one degree. The appliance offers the possibility to choose between three different cooking modes (slow, medium and fast) and to set any desired core temperature. A concentrate of technology that produces tender, juicy, healthy products of the highest quality.

This option automatically sets the ideal temperature inside the oven cavity according to the target temperature set by the user.

1. After setting the desired target temperature, press the  button (at the lower right ).
2. Select the temperature difference value.

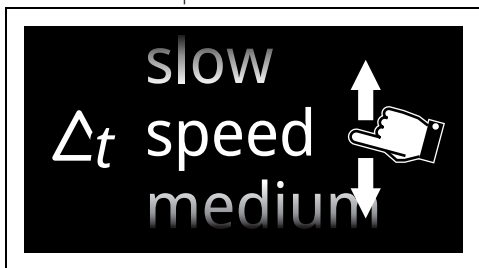

Δt slow

Sets the smallest difference between the probe temperature and the temperature of the oven

cavity. This results in a longer cooking time.

Δt Medium

Sets a medium difference between the probe temperature and oven cavity temperature. This results in a medium cooking time.

Δt fast

Sets the largest difference between the probe temperature and the temperature of the oven cavity. This results in a shorter cooking time.

3. Touch the CONFIRM  button to confirm the selected probe temperature.



Press the  button to eliminating the cooking Δt .

With preheating:

1. Touch the START  button to start pre-heating.

After pre-heating, a buzzer will sound and a message will display to indicate that the food can be put in the oven.

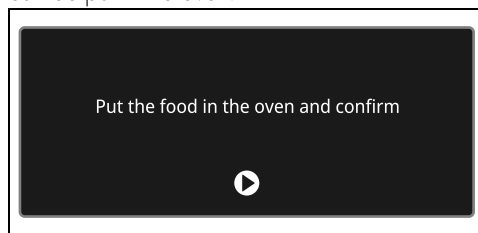

2. Insert the tip of the temperature probe into the food to be cooked.



For best results, make sure that the metal part of the temperature probe is inserted almost completely into the food at a right angle, but make sure that it does not touch the tray underneath.

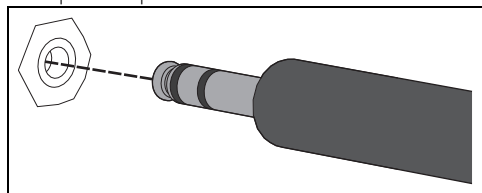

3. Open the appliance door.
4. Insert the tray on which the food has been placed into the appropriate guides.

5. Insert the plug of the temperature probe into the socket at the side, using the probe to open the protective cover.



6. Close the door.
7. Touch the **START**  button to start cooking using the temperature probe.

Without preheating:

1. Touch the **PRE-HEATING**  button to disable pre-heating.
2. Open the appliance door.
3. Insert the tray on which the food has been placed into the appropriate guides.
4. Insert the plug of the temperature probe into the socket at the side, using the probe to open the protective cover.
5. Close the door.
6. Touch the **START**  button to start cooking using the temperature probe.

End of cooking parameters with the temperature probe

Cooking ends when the instantaneous temperature reaches the target temperature set by the user.

The heating elements are switched off and the appliance emits a series of beeps.

1. Open the door.
2. Remove the probe from the food and unplug it from the socket.
3. Remove the food from the oven.
4. Make sure that the protective cover is properly closed.
5. Close the door.

Microwave cooking



Given that they penetrate directly into the food, microwaves allow cooking to take place in a very short period of time and with a considerable saving of energy. They are suitable for cooking without fat and also for defrosting and re-heating food while maintaining its original appearance and fragrance.



When using the microwave, the food (or its container) must not be placed on the bottom of the oven cavity. Use the supplied accessories inserted in the shelves suitable for the recipe you want to make.

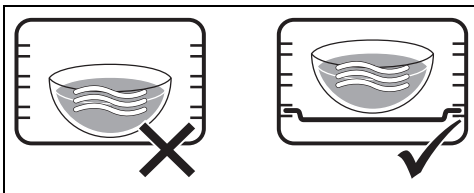

DO NOT USE CONTAINERS/ ACCESSORIES (trays, glass dishes, etc.) RESTING DIRECTLY ON THE BOTTOM OF THE OVEN CAVITY.

1. Open the door.
2. Place the dish into the oven cavity.



When cooking using only the microwave function, the appliance does not perform preheating. The food can be placed immediately inside the appliance.

3. Close the door
4. Touch the **COOKING**  button on the "main menu".
5. Touch the **MICROWAVE COOKING MENU**  button.
6. Select the **MICROWAVE**  function to enter the relevant cooking screen.
7. Touch the **MICROWAVE POWER**  button or the relative value.

8. Scroll through the values and select the required power level of the microwave.

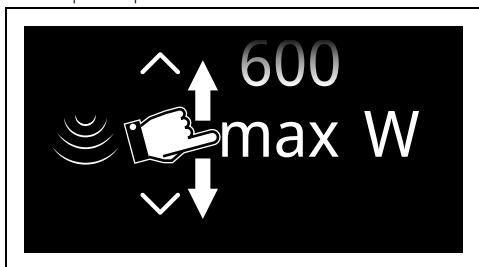

 The power level of the microwave is from 100 W to 600 W or MAX.

9. Touch the CONFIRM  button (at the lower right **3**) to confirm the power level of the microwave that has been selected.

10. Touch the COOKING DURATION  button or the relevant value.

11. Scroll through the values and select the required duration.

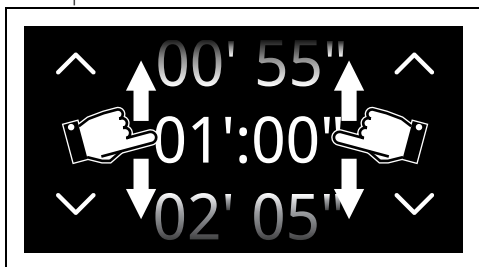

12. Touch the CONFIRM  button to confirm the selected cooking duration.

 The minutes and seconds can be selected separately.

 The duration of the microwave cooking can be from a minimum of 5 seconds to a maximum of 29 minutes and 55 seconds.

13. Touch the START  button (at the lower right **3**) to start the microwave cooking.

 Each time the door is opened, the function in progress will stop. To resume cooking, close the door and confirm.

End of cooking

At the end of cooking, "Function ended" displays and a buzzer sounds briefly, which can be deactivated by touching any point of the display or by opening the door.





- Touch the HOME  button to quit the function.

Microwave power levels

Below is a list of the power levels that can be selected:

Power (W)	Uses
100	
200	Thawing food
300	
400	
500	Delicate cooking
600	Re-heating and cooking food
max.	Heating liquids



Combination cooking with microwave

  Combination cooking is a mix of traditional cooking and microwave operation. These functions are marked by the microwave function icon and the symbol of a traditional function switching on.

1. Touch the COOKING  button on the "main menu".
2. Touch the MICROWAVE COOKING MENU  button.
3. Select a combination function (for example FAN-HEATED MICROWAVE ) to enter the relevant cooking screen.
4. Touch the TEMPERATURE  button or the relevant value.

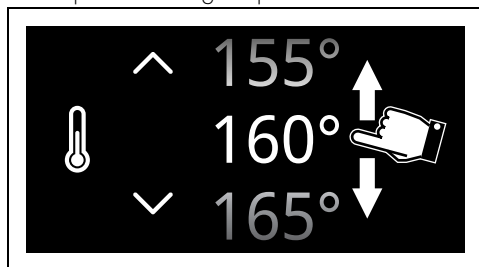
5. Scroll through the values and select the required cooking temperature.



6. Touch the CONFIRM  button (at the lower right ) to confirm the cooking temperature that has been selected.
7. Touch the MICROWAVE POWER  button or the relevant value.
8. Scroll through the values and select the required power level of the microwave.

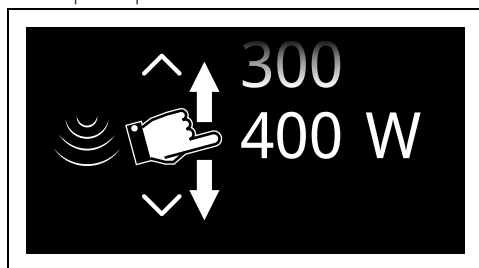



 The power level of the microwave is from 100 W to 400 W.

9. Touch the CONFIRM  button to the microwave power level.
10. Touch the COOKING DURATION  button or the relevant value.

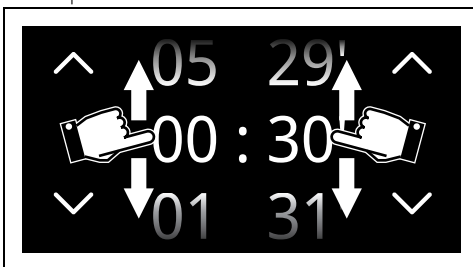
11. Scroll through the values and select the required duration.



 The hours and minutes can be selected separately.

 The duration of the combined microwave cooking function can be from a minimum of 1 minute to a maximum of 5 hours and 59 minutes.

12. Touch the CONFIRM  button to confirm the selected cooking duration.
13. Touch the START  button (at the lower right ) to start the combined microwave cooking.



Preheating stage

Cooking itself is preceded by a preheating stage, which allows the appliance to heat to the cooking temperature more quickly.

This stage is indicated by a progressive increase in the temperature level reached.



 Unless otherwise indicated in the recipe, it is not recommended to place food in the oven during the preheating stage.

 You can skip the pre-heating phase by pressing the button  related.

After pre-heating, a buzzer will sound and a message will display to indicate that the food

can be put in the oven.

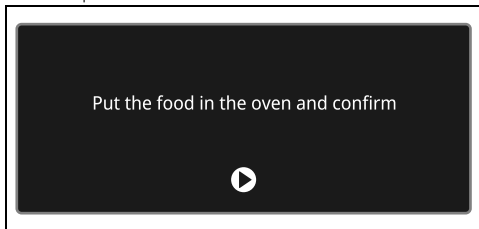

Cooking phase

1. Open the door
2. Place the dish with the food to be cooked into the oven cavity.
3. Close the door.
4. Touch the START  button to start cooking.

This stage is indicated by a progressive increase in the cooking level.



End of cooking

At the end of cooking, "Function ended" displays and a buzzer sounds briefly, which can be deactivated by touching any point of the display or by opening the door.



- Touch the HOME  button to quit the function.

List of combined microwave cooking functions

FAN-ASSISTED MICROWAVE

 The operation of the fan, combined with traditional cooking, ensures consistent cooking even with complex recipes. Using the microwave on the other hand leads to rapid internal cooking of the food.

MICROWAVE + FAN-HEATED

 For combination cooking of food in a short time thanks to the microwave action working together with hot air circulation.

MICROWAVE + GRILL



The use of the grill results in perfect browning of the food's surface. Using the microwave on the other hand leads to rapid internal cooking of the food.

MICROWAVE + FAN-HEATED BASE



Intense heat is supplemented by the microwave function, speeding up cooking times and keeping food soft and moist.

Steam cooking



If cooking has just been performed with temperatures greater than 100°C, you must wait for the oven to cool in order to use the steam function.

1. Touch the COOKING  button on the "main menu".

2. Touch the STEAM COOKING MENU



button.

3. Select the STEAM function  to enter the relevant cooking screen.

4. Touch the TEMPERATURE  button or the relevant value.

5. Scroll through the values and select the required cooking temperature.

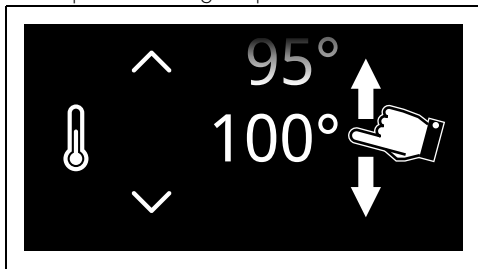



The steam cooking temperature can be from a minimum of 30°C (90°F) to a maximum of 100°C (210°F).

6. Touch the CONFIRM  button (at the lower right **3**) to confirm the cooking temperature that has been selected.

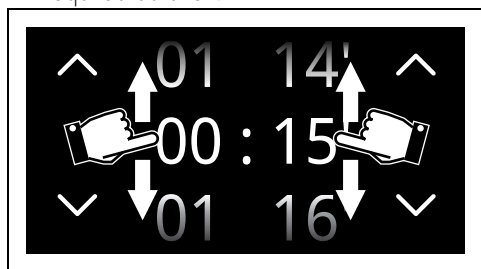

- Touch the COOKING DURATION  button or the relevant value.
- Scroll through the values and select the required duration.



 The minutes and seconds can be selected separately.

 The duration of the steam function can be from a minimum of 1 minute to a maximum of 1 hour and 59 minutes.

 The expected time for the end of cooking is shown under the duration; the minutes needed for preheating are already calculated.

- Touch the CONFIRM  button to confirm the selected cooking duration.
- Touch the START  button (at the lower right ) to start the reservoir filling procedure.

Reservoir filling

 Use cold tap water which is not too hard, softened water or still mineral water.

 Do not use distilled water, tap water with a high chloride content (> 40 mg/l), or other liquids.

- Fill a jug or a container with sufficient water for the cooking duration.
- Open the appliance door.
- Place the jug (or container) on the open door.

 The jug (or container) with the water must have a gross weight lower than 5 kg.

- Remove the loading wand from its holder.

- To remove the loading wand, press on the front of the wand until the spring contracts, then release.

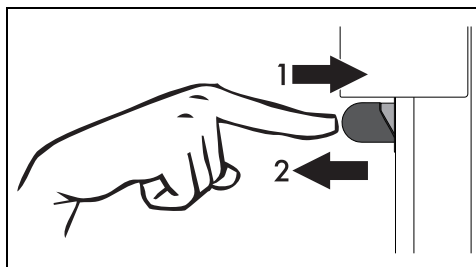



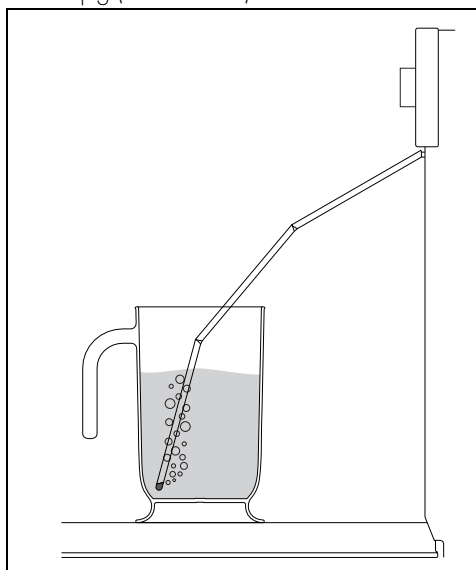

fig. 1
or

- Touch the WAND button  on the display (positioned in the lower area ).

 Pay attention to the distance to be maintained so as not to be hit by the wand projection.

- Place the end of the tube at the bottom of the jug (or container).



- Press the start  button to start filling the appliance reservoir with water.

 The appliance will automatically draw the quantity of water necessary for cooking on the basis of the set duration.



In the event that the water runs out, the appliance will automatically stop the cooking process, a buzzer will sound and the display will show a request to fill the reservoir with water.

- When finished, shake the loading wand to remove any water residue.

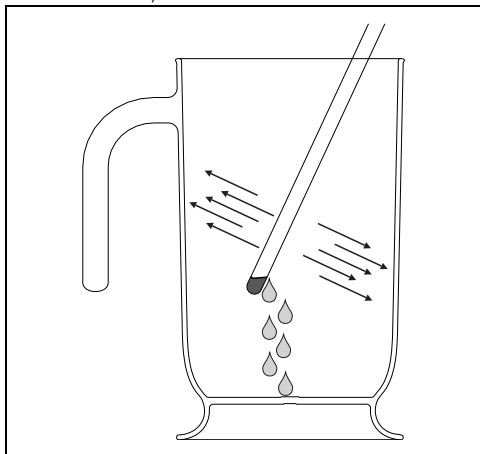

- Place the loading wand back in its holder.
- Remove the jug (or container).
- Close the door.



When the door is closed, an automatic system will automatically draw in any residual water in the loading wand to avoid drips. A bubbling noise may be heard; this is completely normal.

- Touch the CONFIRM  button to confirm that you have finished filling the reservoir. The appliance starts the function using the parameters set.



Each time the door is opened, the function in progress will stop and then automatically restart when the door is closed again.

Preheating stage

Cooking itself is preceded by a preheating stage, which allows the appliance to heat to the cooking temperature more quickly.

This stage is indicated by a progressive increase

in the temperature level reached.



Unless otherwise indicated in the recipe, it is not recommended to place food in the oven during the preheating stage.



You can skip the pre-heating phase by pressing the button  related.

After pre-heating, a buzzer will sound and a message will display to indicate that the food can be put in the oven.

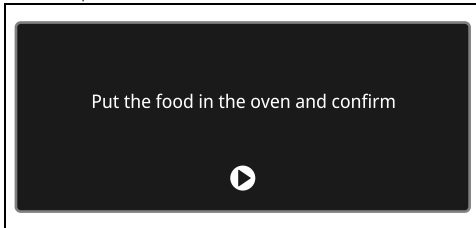

Cooking phase

- Open the door
- Place the dish with the food to be cooked into the oven cavity.
- Close the door.
- Touch the START  button to start cooking.

This stage is indicated by a progressive increase in the cooking level.



End of cooking

At the end of cooking, "Function ended" displays and a buzzer sounds briefly, which can be deactivated by touching any point of the display or by opening the door.



- Touch the HOME  button to quit the function.

Reservoir draining



Before draining the reservoir, wait for the oven to cool down, leaving the door open. To make sure that the water remaining in the reservoir is not too hot, wait at least 40 minutes.



It is recommended to drain at the end of each cooking, to prevent any residue of unused water from remaining inside the reservoir.



After a long period of inactivity it is recommended to make a reservoir filling and draining cycle to rinse the steam circuit.

1. Stand to the side of the appliance and open the door ajar for a few seconds to allow excess steam to escape.
2. Fully open the door when safe to do so and cautiously remove the food from the oven.
3. Place a jug or a container on the open door.
4. Pull the loading nozzle out of its housing.
5. Press the START  button to start draining the water into the jug (or container).

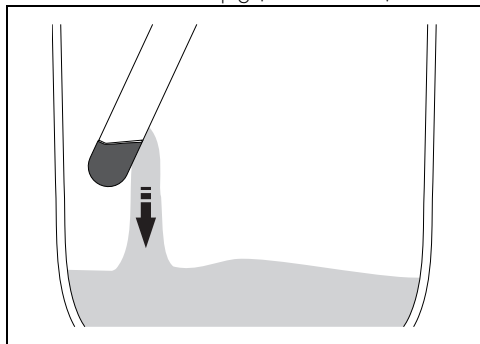

When complete, the display will indicate that the residual water removal process is complete.

Reservoir emptying ended



6. Touch the CONFIRM button .

7. Shake the loading nozzle to remove any remaining water.
8. Place the loading nozzle place in its housing.
9. Remove the jug (or container).
10. Remove condensation from the base and walls of the oven cavity, the door glass and drip tray and the front of the appliance using a sponge.







Take care: the water may be very hot.





The drained water cannot be used for other cooking.

Combination cooking with steam

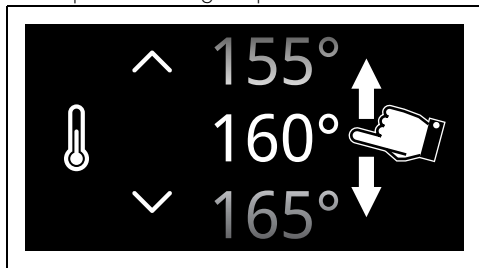
1. Touch the COOKING  button on the "main menu".
2. Touch the STEAM COOKING MENU  button.
3. Select a combination function (for example STEAM FAN-HEATED ) to enter the relevant cooking screen.
4. Touch the TEMPERATURE  button or the relevant value.
5. Scroll through the values and select the required cooking temperature.



6. Touch the CONFIRM  button (at the lower right **3**) to confirm the cooking temperature that has been selected.
7. Touch the STEAM PERCENTAGE  button or the relevant value.

8. Scroll through the values and select the required steam percentage.

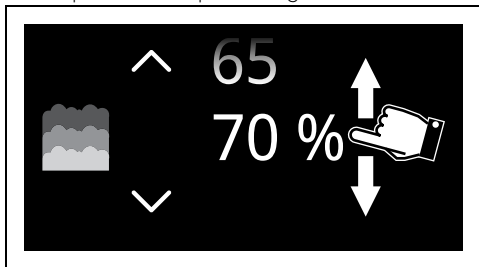



-  25% - Cakes and bread
30% - Duck
40% - Beef, veal and lamb
50% - Chicken
70% - Whole fish

9. Touch the CONFIRM  button to confirm the steam percentage that has been selected.

10. Touch the COOKING DURATION  button or the relevant value.

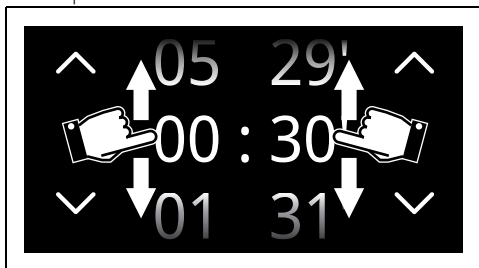
11. Scroll through the values and select the required duration.



-  The hours and minutes can be selected separately.

-  The duration of the combined steam function can be from a minimum of 1 minute to a maximum of 12 hours and 59 minutes.

-  The expected time for the end of cooking is shown under the duration; the minutes needed for preheating are already calculated.

12. Touch the CONFIRM  button to confirm the selected cooking duration.

13. Touch the START  button (at the lower right **3**) to start the reservoir filling procedure.

14. Proceed with reservoir filling as described above.



Preheating stage

Cooking itself is preceded by a preheating stage, which allows the appliance to heat to the cooking temperature more quickly.

This stage is indicated by a progressive increase in the temperature level reached.



-  Unless otherwise indicated in the recipe, it is not recommended to place food in the oven during the preheating stage.

-  You can skip the pre-heating phase by pressing the button  related.

After pre-heating, a buzzer will sound and a message will display to indicate that the food can be put in the oven.

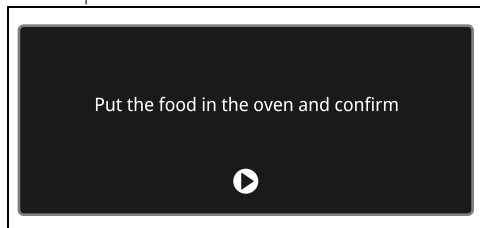

Cooking phase

1. Open the door
2. Place the dish with the food to be cooked into the oven cavity.
3. Close the door.
4. Touch the START  button to start cooking.

This stage is indicated by a progressive increase in the cooking level.



End of cooking

At the end of cooking, "Function ended" displays and a buzzer sounds briefly, which can

be deactivated by touching any point of the display or by opening the door.



- Touch the HOME  button to quit the function.
5. Proceed with draining the reservoir as described above.

Drying after steam functions

Cooking with steam generates a lot of moisture inside the appliance. This is a normal phenomenon and does not affect the appliance's operation in any way.

Each time you finish cooking:

1. let the appliance cool down;
2. thoroughly dry the oven cavity and the accessories used with a soft cloth or paper towels;
3. leave the door open until the inside of the appliance has dried completely.

List of combined steam cooking functions

FAN ASSISTED+STEAM



Intense and uniform cooking. The addition of steam allows better preservation of the properties of the food. Ideal for roast veal, roast duck and cooking whole fish.

THERMALLY FAN-ASSISTED STEAM



The addition of steam to thermally fan-assisted cooking allows better preservation of the properties of the food. Ideal for preparing roasts, chicken and baked goods like leavened cakes and bread.

STEAM WITH FAN-HEATED BASE



Allows you to quickly finish cooking food that is already cooked on the outside but not on the inside.

Advice for steam cooking

- **Pasta and rice:** upon reaching 100°C, the cooking time will be the same as with cooking on a hob. Place the pasta or rice in a metal tray and cover with around a centimetre of water. For best results when cooking rice, place a lid on the container or cover with aluminium foil. This procedure allows the rice to absorb all the water, and it

can then be served directly to the table.

- **Eggs:** these may be **boiled**, **scrambled** or **poached** by using the steam function at 100°C. To obtain perfect **boiled eggs**, place them on the perforated tray and cook for 4-6 minutes for soft boiled eggs and 8-10 minutes for hard-boiled eggs. For **scrambled eggs**, place the beaten eggs in a metal tray together with milk, butter and seasoning. Cover the tray with aluminium foil. Mix every couple of minutes using a fork. For **poached eggs**, pour boiling water into the metal tray with a drop of vinegar and steam cook for around 4-5 minutes.
- **Vegetables:** steam cooking vegetables gives excellent results. They maintain their colour, flavour and nutritional properties. For dense vegetables such as potatoes, turnips and parsnips, cook at 100°C for the same length of time you would boil them on a hob. For broccoli and carrots, cook for 6 minutes if you want them to remain firm, or 10 minutes if you want them to be softer.
- **Fish:** due to the delicate nature of fish, steaming gives excellent results. For oily fish such as salmon or trout, cook at 100°C for around 5 minutes. For white fish such as cod or haddock, cook at 80°C for around 5 minutes. If you are cooking different foods, all fish must be cooked in the perforated tray which must be placed on the bottom shelf of the oven to avoid liquid from the fish dripping onto other food products.
- **Meat:** casseroles and curries are ideal for steam cooking. Prepare the casserole as for normal oven cooking. Place it in a metal tray, cover with a lid or aluminium foil, and cook for between 45 minutes and 3 hours depending on the cut of meat used.
- **Thin soups:** steam cooking allows flavours to develop perfectly with minimum effort, as the liquids will not boil over. For vegetable soup with the correct consistency, first steam the vegetables, then add broth and steam cook at 100°C. The steam function is also ideal for preparing large quantities for later use.
- **Soups:** Thicker soups are also easy and quick to prepare. Place the soup in a metal tray, cover with a lid or aluminium foil and steam cook at 100°F for the same time you would cook it in a microwave oven. To obtain a creamy texture stir halfway through cooking.

- **Reheating:** the steam cooking function will not dry foods out and gives a moister result. A previously prepared home-cooked meal, covered with aluminium foil, will take around 10-12 minutes to reheat. Ready meals will require approximately double the time indicated on the package.
- **Defrosting:** it is possible to use the steam function to defrost foods. Times vary, but defrosting with the steam cooking function takes around half the time necessary for covered foods left to defrost at room temperature.
- **Peeling peppers and tomatoes:** this is very easy to do when using the steam function. Use a knife to cut a small cross in the skin of the tomato, and steam cook for 1 minute. Peppers have tougher skin, and may require up to 4 minutes to soften it sufficiently for peeling.
- **Chocolate:** this can be melted using the steam cooking function. Place the chocolate in a metal tray, cover with aluminium foil and steam cook for 1 minute. Unlike other methods, chocolate is unlikely to burn in the steam oven.
- **Hot towels:** ideal for facial treatments, a close shave or for use after a meal, these are easy to prepare using the steam cooking function. Moisten a towel with water, roll it up and steam it for 1 minute.

Cooking advice

General advice

- Use a fan assisted function to achieve consistent cooking at several levels.
- It is not possible to shorten cooking times by increasing the temperature (the food could be overcooked on the outside and undercooked on the inside).

Advice for cooking meat

- Cooking times vary according to the thickness and quality of the food and to consumer taste.
- Use a meat thermometer when roasting meat, or simply press on the roast with a spoon. If it is hard, it is ready; If not, it needs another few minutes cooking.

Advice for cooking with the Grill and the Fan with grill

- Meat can be grilled even when it is put into the cold oven or into the preheated oven if you wish to change the effect of the

cooking.

- When using the fan-assisted with grill function, we recommend that you preheat the oven before grilling.
- We recommend placing the food at the centre of the rack.
- With the Grill function, we recommend that you set the temperature to the maximum value to optimise cooking.

Advice for cooking desserts/pastries and biscuits

- Use dark metal moulds: They help to absorb the heat better.
- The temperature and the cooking time depend on the quality and consistency of the dough.
- To check whether the dessert is cooked right through: At the end of the cooking time, put a toothpick into the highest point of the dessert. If the dough does not stick to the toothpick, the dessert is cooked.
- If the dessert collapses when it comes out of the oven, on the next occasion reduce the set temperature by about 10°C, selecting a longer cooking time if necessary.

Advice for defrosting and proving

- Place frozen foods without their packaging in a lidless container on the first shelf of the oven.
- Avoid overlapping the food.
- To defrost meat, use the rack placed on the second level and a tray on the first level. In this way, the liquid from the defrosting food drains away from the food.
- The most delicate parts can be covered with aluminium foil.
- For successful proving, a container of water should be placed in the bottom of the oven.

To save energy

- Stop cooking a few minutes before the time normally used. Cooking will continue for the remaining minutes with the heat which has accumulated inside the oven.
- Reduce any opening of the door to a minimum to avoid heat dispersal.
- Keep the inside of the appliance clean at all times.

Sous Vide cooking



SOUS VIDE

Steam function for perfect cooking inside a sealed bag. The food's flavours are enhanced and no nutrients are lost.



The bag containing the food can be placed on the perforated tray or on a rack positioned on the first or second shelf.

Sous vide cooking in a steam oven is the best way to cook food without altering its nutritional properties and quality. It is also an extremely healthy and natural type of cooking.

- The Sous vide technique allows the heat to be transferred efficiently from the steam to the food, preventing the loss of flavour through the oxidation and evaporation of nutrients and humidity during cooking.
- Sous vide cooking also allows greater control over the cooking compared to traditional methods and ensures that cooking is uniform.
- It also allows cooking to be carried out at lower temperatures compared to traditional cooking methods.

For Sous Vide cooking you need to:

- Have a chamber vacuum packing machine that allows you to achieve a better and safer vacuum for solid and liquid foods.
- Make sure that the seal area of the bag is clean and free from food residues.
- Hermetically seal the food in a special food grade bag that can withstand the cooking temperatures.
- Create a vacuum in the bag of at least 99.8% to prevent air bubbles forming inside that could affect the cooking.
- If you have a Smeg vacuum drawer, use the maximum vacuum level (level 3).

Once cooked, it is recommended to remove the product from the bag and finish cooking it in a pan or by grilling.

Tips:

- Preferably use fresh, high quality raw materials well-preserved until cooked.
- To improve the cooking result, dressings can be added inside the bag.
- Clean the food well from bones or fishbones that could pierce the bag and damage the cooking.
- Do not leave the food to be cooked for too

long at room temperature as the bag may swell during cooking, losing all the advantages of vacuum.

- The food to be vacuum-packed for Sous Vide cooking or storage must be at a refrigerator temperature (from 3°C to 7°C), never hot.
- Keep the products in a vacuum (cooked and then blast chilled) at a constant temperature not exceeding 3°C in the refrigerator.
- For even cooking, do not overfill the bags and place the food in the best possible way on a single layer.
- If you are cooking multiple bags at the same time, place the bags on the same shelf without overlapping them.
- Do not reuse the bags after cooking.

To select the Sous Vide cooking:

1. Touch the COOKING  button on the "main menu".
2. Touch the STEAM COOKING MENU



button.

1. Select the SOUS VIDE  function.
2. For settings, see the procedure described in the "Steam cooking" paragraph.

Humidified cooking



Level 1





comparable to cooking with a lid, it is suitable for preparing pizzas, large sausages, whole pork fillets, chicken breasts, fish steaks, quiches, stewed vegetables, bread...

Level 2

recommended for roast chicken, turkey breast, pork loin, medium size fish, roasted potatoes, low temperature cooking of large lean roasts, pasteurisation, egg pasta...

Level 3

comparable to cooking with a lid and with the addition of wine. It is recommended for braised meats, stews, shoulder roasts, large fish, casseroles, stewed potatoes, fish and vegetables stews.....

1. Touch the COOKING  button on the "main menu".
2. Touch the HUMIDIFIED COOKING MENU  button.
3. Select a humidified function (for example FAN-HEATED ) to enter the relevant cooking screen.
4. Touch the TEMPERATURE  button or the relevant value.
5. Scroll through the values and select the required cooking temperature.

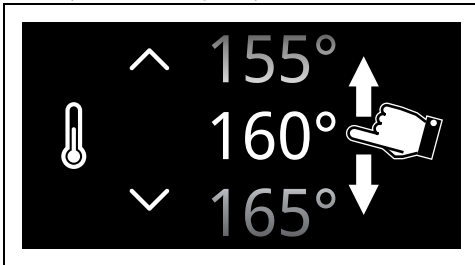



6. Touch the CONFIRM  button (at the lower right ) to confirm the cooking temperature that has been selected.

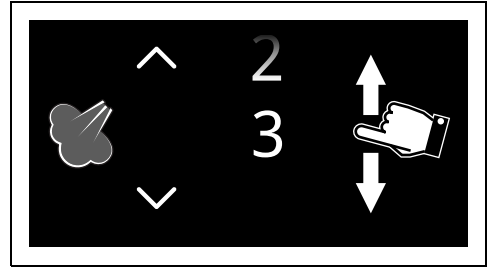

7. Touch the STEAM LEVEL  button or the relevant value.
8. Scroll through the values and select the required steam level.



The steam level that can be selected depends on the set cooking duration:
Level 1: always available;
Level 2: 30 minutes and upwards;
Level 3: 45 minutes and upwards.



With the MANUAL steam level selection, injections of steam can be introduced as wished with the  button during cooking. Injections of steam are active as long as the indicator light  is flashing (for a duration of approx. 8 minutes).

9. Touch the CONFIRM  button to confirm the steam level that has been selected.
10. Touch the COOKING DURATION  button or the relevant value.
11. Scroll through the values and select the required duration.

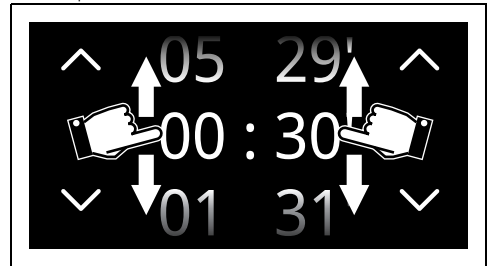



The hours and minutes can be selected separately.



The duration of the combined steam function can be from a minimum of 1 minute to a maximum of 12 hours and 59 minutes.



The expected time for the end of cooking is shown under the duration; the minutes needed for preheating are already calculated.

12. Touch the CONFIRM  button to confirm the selected cooking duration.
13. Touch the START  button (at the lower right **3**) to start the reservoir filling procedure.
14. Proceed with reservoir filling as described above.

Preheating stage

Cooking itself is preceded by a preheating stage, which allows the appliance to heat to the cooking temperature more quickly.

This stage is indicated by a progressive increase in the temperature level reached.



Unless otherwise indicated in the recipe, it is not recommended to place food in the oven during the preheating stage.



You can skip the pre-heating phase by pressing the button  related.

After pre-heating, a buzzer will sound and a message will display to indicate that the food can be put in the oven.

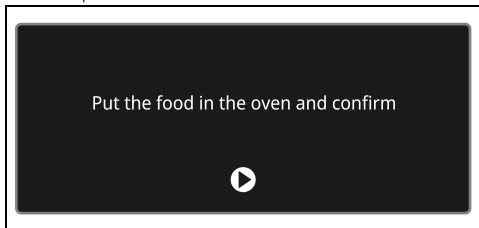

Cooking phase

1. Open the door
2. Place the dish with the food to be cooked into the oven cavity.

3. Close the door.
4. Touch the START  button to start cooking.

This stage is indicated by a progressive increase in the cooking level.



End of cooking

At the end of cooking, "Function ended" displays and a buzzer sounds briefly, which can be deactivated by touching any point of the display or by opening the door.



- Touch the HOME  button to quit the function.
5. Proceed with draining the reservoir as described above.

List of humidified cooking functions

FAN-ASSISTED



Intense heat is created by injections of steam that speed up cooking but allow the food to remain soft and moist. Ideal for biscuits, cakes and multilevel cooking.

FAN-HEATED



Intense heat is created by injections of steam that speed up cooking but allow the food to remain soft and moist. Ideal for biscuits, cakes and cooking on more than one level

TURBO



Allows quick cooking on multiple shelves without mixing the aromas. Perfect for large volumes that call for intense cooking. The injection of steam speeds up cooking without drying out the food.

FAN-ASSISTED GRILL



The intense heat from the grill is distributed by the fan along with injections of steam; this creates optimal conditions for grilling even thick slices of meat without drying them out.

FAN-HEATED BASE





Intense heat is created by injections of steam that speed up cooking, but allow the food to remain soft and moist. Ideal for pies.

MultiTech cooking

1. Touch the COOKING  button on the "main menu".

2. Touch the MULTITECH COOKING MENU  button.

3. Select the MULTITECH  or TWINTECH  to enter the relevant cooking screen.

4. As described in the previous chapters, touch the buttons for TEMPERATURE 

COOKING DURATION 

MICROWAVE POWER  STEAM

PERCENTAGE  (MULTITECH only) or their respective values.

5. Scroll through the values and select the desired settings.

6. Touch the CONFIRM  button (at the lower right **3**) to confirm the values that have been selected.

7. Touch the START  button (at the lower right **3**) to start the reservoir filling procedure.

8. Proceed with reservoir filling as described above.

Preheating stage

Cooking itself is preceded by a preheating stage, which allows the appliance to heat to the cooking temperature more quickly.

This stage is indicated by a progressive increase

in the temperature level reached.



Unless otherwise indicated in the recipe, it is not recommended to place food in the oven during the preheating stage.



You can skip the pre-heating phase by pressing the button  related.

After pre-heating, a buzzer will sound and a message will display to indicate that the food can be put in the oven.

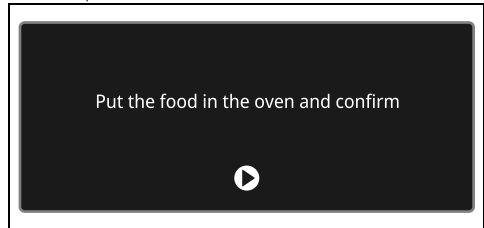

Cooking phase

1. Open the door
2. Place the dish with the food to be cooked into the oven cavity.
3. Close the door.
4. Touch the START  button to start cooking.

This stage is indicated by a progressive increase in the cooking level.



End of cooking

At the end of cooking, "Function ended" displays and a buzzer sounds briefly, which can be deactivated by touching any point of the display or by opening the door.



- Touch the HOME  button to quit the function.
5. Proceed with draining the reservoir as described above.

List of multitech cooking functions

MULTITECH



The function uses all cooking technologies simultaneously. Steam, microwave and convection cooking guarantee innovative results with time savings of up to 70% compared to traditional cooking.

TWINTeCH



The function combines steam and microwave cooking for faster preparation, while maintaining the excellent results of pure steam cooking.

Smart Cooking

This mode allows you to select a previously stored program for cooking food. The appliance automatically calculates the optimum cooking parameters based on the weight selected.

1. Touch the **SMART COOKING**  button on the "main menu" (in the main area **2**).

2. Select the type of dish required from the **SMART COOKING** menu (for example "VEGETABLES" ).

3. Select the sub-category of dish to cook (for example "MIXED GRILLED VEGETABLES" ).

4. Scroll through the values to set the weight of the food to be cooked.

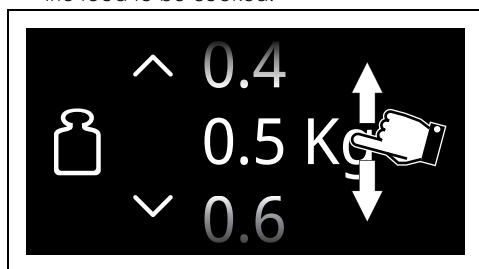

5. Touch the **CONFIRM**  button to confirm the settings.



It is now possible to save the settings as a personal recipe (see section "My recipes").

6. Touch the **START**  button to start **SMART COOKING**.

Cooking will start with the settings specified in the program.





The cooking temperature and duration can be changed at any time, even after cooking has started.

Sametime



In this section you will find recipes created by Smeg chefs for **SAMETIME** cooking. This category allows a complete preparation at the same time. By choosing available combinations and setting the number of portions, the appliance selects the most suitable function, time and temperature. The instructions on the display indicate when to put the food in the oven and on which shelf.

1. Touch the **SMART COOKING**  button on the "main menu".
2. Scroll through the functions until you select **SAMETIME** .
3. Select the desired **SAMETIME** recipe and follow the instructions on the display.

Quick recipes













In this section you will find recipes created by Smeg chefs for cooking quick recipes. This category allows you to prepare traditional recipes in less time. By choosing the type and weight of food, the appliance selects the most suitable function, time and temperature. The instructions on the display indicate when to put the food in the oven and on which shelf.

1. Touch the **SMART COOKING**  button on the "main menu".
2. Scroll through the functions until you select **QUICK RECIPES** .
3. Select the desired quick recipe and follow the instructions on the display.

Multistep cooking



Multistep cooking means the possibility to start cooking with a certain function and to proceed with the cooking and finish it with different functions set by the user.

1. Touch the MULTISTEP  button on the "main menu" (in the main area ).
2. Touch the ADD STEP  button.
3. Select the wished function for the first step (traditional, microwave, steam...).
4. As described in the previous chapters, touch the buttons for TEMPERATURE 
COOKING DURATION 
MICROWAVE POWER LEVEL 
STEAM PERCENTAGE  (depending on the selected function) to select the parameters you want to change.
5. Scroll through the values and select the desired settings.
6. Touch the CONFIRM  button (at the lower right ) to confirm the values that have been selected.
7. Touch again the ADD STEP  button.
8. Select the wished function for the second step (traditional, microwave, steam...).
9. Set the desired parameters for the second function.



A maximum of 3 steps can be set.







It is not possible to add a next step if no cooking time or probe temperature (if present) has been set.



It is not possible to start a cooking process if a duration or probe temperature (if present) for all steps has not been set.





It is not possible to set a cooking time of more than 13 hours.

10. Touch the CONFIRM  button to confirm the selected values.
11. Touch the ADD STEP  button again if you want to add a new cooking step, or touch the START button  (at the lower right ) to start the Multistep cooking.



History

This menu is particularly useful for viewing and reusing the last programs or personal recipes that were used.

1. Touch the HISTORY  button on the "main menu" (at the left  in the lower area).
2. Select the function you wish to reuse and proceed with cooking as described in the previous sections.

Deleting the history

If you wish to delete the history:

1. Touch the HISTORY  button on the "main menu".
2. Touch the DELETE  button to delete the history.

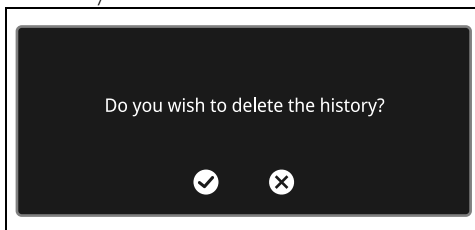

3. Touch the CONFIRM  button to confirm that you wish to delete the history (or the CANCEL  button to cancel the operation).

Mini guide to accessories

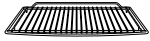

Rack

We recommend the use of the grill as a support surface for baking moulds/casseroles.

In the absence of the baking tray grill, the grill can be used as a base for grilling with the deep baking tray placed on a shelf below to collect the juices.



Glass dish

Use the glass dish by placing it on the grid.

It is suitable for microwave and combination microwave cooking.



Perforated tray

Use the perforated baking tray with the steel pan placed on the level below.

It is suitable for steam and combination steam and cooking.



Tray rack

We recommend using the baking tray grill as a base for food to grill. The pan below collects the juices from the grills.

We recommend the use of the deep baking tray for cooking on one level only.

Place the deep baking tray on the centre shelf when using the fan-assisted functions. When



Deep tray

using the STATIC function,  place the deep baking tray on the required shelf.

Place the baking tray on the last shelf with the baking tray grill to cook in GRILL mode .

WARNING: The deep tray can be used for combined microwave cooking. Do not use it for microwave cooking only.

Discover the recipes

To consult the recipes developed for various categories of food and to get more information on cooking suggestions, we recommend visiting the dedicated page on the www.smeg.com website, which can be reached using the QR code on the leaflet supplied with the product.

My recipes



This menu allows you to enter a personal program with the parameters you wish to use. On first use, the appliance will only offer you to add a new recipe. After storing your personal recipes these will then be available in the dedicated menu.

1. Touch the MY RECIPES  button on the "main menu" (in the main area .





It is possible to store a limited number of personal recipes.

Adding a recipe

1. Touch the NEW RECIPE  button.
2. Select the required function.
3. Touch the TEMPERATURE  button or the relevant value.

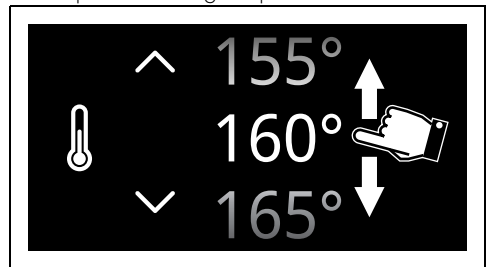
4. Scroll through the values and select the required cooking temperature.



5. Touch the CONFIRM  button to confirm the cooking temperature that has been selected.
6. Touch the COOKING DURATION  button or the relevant value.
7. Scroll through the values and select the required duration.

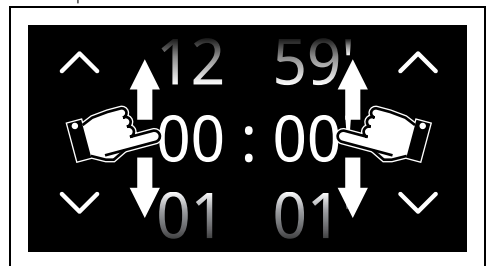

8. Touch the CONFIRM  button to confirm the selected cooking duration.

 The minutes required for preheating are already included in the end-of-cooking time.

 Now it is possible to add programmed cooking.

Saving a recipe

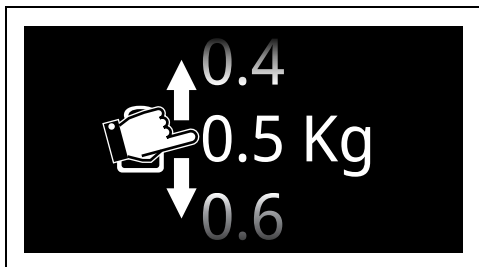

9. Touch the SAVE  button.
10. Scroll through the values to set the RACK.
11. Scroll through the values to set the weight of the food to be cooked.





12. Touch the CONFIRM  button to confirm the settings.

At this point, a name for the recipe must be entered.

13. Use the alphanumeric keypad to enter the name of the recipe to be saved.

 Use the  and  buttons to switch from the alphabetic keypad to the numerical keypad and vice versa.

 The recipe name can contain a maximum 12 characters, including spaces.



 The name must contain at least one character in order to store the recipe.

 The character  deletes the previous letter.



14. Touch the CONFIRM  button to store the program.



Starting a personal recipe

1. Touch the MY RECIPES  button on the "main menu".
2. Select the recipe that was saved previously.
3. Touch the START  button to start cooking.

Deleting a recipe

1. Touch the MY RECIPES  button on the "main menu".
2. Select the recipe that was saved previously.
3. Touch the DELETE  button to delete the recipe.



4. Touch the CONFIRM  button to confirm that you wish to delete the selected recipe (or the CANCEL  button to cancel the operation).

Other functions

The special functions menu includes several functions such as defrosting, proving or cleaning...

- Touch the OTHER FUNCTIONS  button on the "main menu".

 Certain functions are not available on all models.

DEFROST BY WEIGHT



Automatic defrosting function. Choose the dish, the oven calculates the time necessary for proper defrosting.



If the internal temperature is greater than the one required, the function will be stopped immediately and "Internal temperature unsafe, please wait until the oven is cool" will display. Allow the appliance to cool down before activating the function.



It is not possible to change the default temperature for the Defrost by weight function.



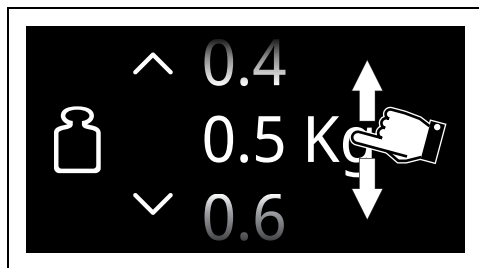

1. Open the door.
2. After weighing the food, place it in the oven cavity.
3. Close the door.
4. Select DEFROST BY WEIGHT 
5. Select the type of food to defrost from the categories MEAT - FISH - BREAD - DESSERTS
6. Scroll through the values to set the weight of the food to be defrosted.



7. Touch the CONFIRM  button to confirm the settings.
8. Touch the START  button to start the defrost by weight function.

When finished, a buzzer sounds briefly, which can be deactivated by touching any point of the display or by opening the door.

Preset parameters:

Type	Weight (kg)	Time (minutes)
 Meats	0.5	18
 Fish	0.3	25
 Bread	0.1	5
 Desserts	0.1	5



Defrosting times may vary on the basis of the shape and size of the food to be defrosted.



When defrosting heavy and/or irregularly shaped food (e.g. chicken, fish, etc.), it is advisable to turn it inside the oven cavity at least once by 180°.

DEFROST BY TIME



Manual defrosting function. Select the length of time required for defrosting, when the set time has elapsed, the function will stop.



If the internal temperature is greater than the one required, the function will be stopped immediately and "Internal temperature unsafe, please wait until the oven is cool" will display. Allow the appliance to cool down before activating the function.



The duration of the Defrost by time function can be from a minimum of 1 minute to a maximum of 12 hours and 59 minutes.





It is not possible to change the default temperature (30°C) for the Defrost by time function.

1. Open the door.
2. Place the dish into the oven cavity.
3. Close the door.
4. Select DEFROST BY TIME 

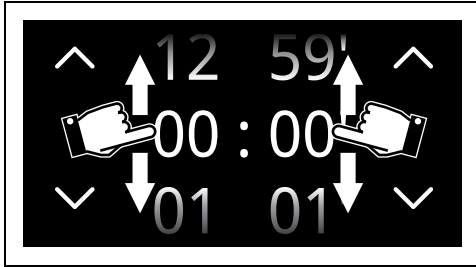
5. Touch the COOKING DURATION  button or the relevant value.
6. Scroll through the values and select the required duration.



7. Touch the CONFIRM  button to confirm the settings.
8. Touch the START  button to start the Defrost by time function.
When finished, a buzzer sounds briefly, which can be deactivated by touching any point of the display or by opening the door.
9. Touch the HOME  button to quit the function.

PROVING



This function is particularly suitable for proving dough.



If the internal temperature is greater than the one required, the function will be stopped immediately and "Internal temperature unsafe, please wait until the oven is cool" will display. Allow the appliance to cool down before activating the function.



For successful proving, a container of water should be placed in the bottom of the oven.

1. Open the door
2. Position the dough to prove on the second level.
3. Close the door.
4. Select PROVING .



5. Touch the COOKING DURATION  button or the relevant value.

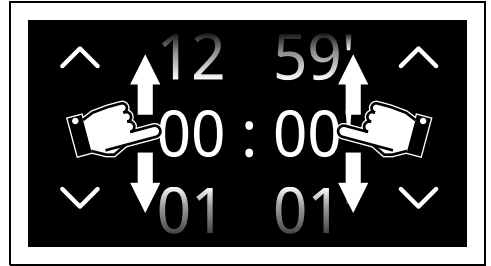

The duration of the Proving function can be from a minimum of 1 minute to a maximum of 12 hours and 59 minutes.

6. Scroll through the values and select the required duration.



7. Touch the TEMPERATURE  button or the relevant value.
8. Scroll through the values and select the required cooking temperature (from 25°C to 40°C).
9. Touch the CONFIRM  button to confirm the settings.
10. Touch the START  button to start the Proving cycle.

When finished, a buzzer sounds briefly, which can be deactivated by touching any point of the display or by opening the door.

PLATE WARMING



Function that heats and keeps plates warm. Position a baking tray on the lowest shelf and put the plates on it to warm.

1. Position the tray on the first shelf and place the plates to be warmed at the centre of it.

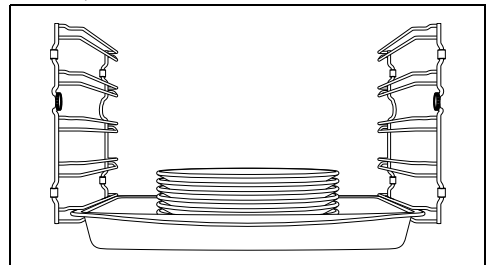



Do not stack plates too high. Stack plates a maximum of 5/6 high.

2. Select PLATE WARMING 

3. Touch the START  button to start the Plate warming function.

 Unless otherwise set, the Plate warming function has a maximum duration of 12 hours and 59 minutes.

The following can be set while the function is in operation:

- the temperature  (from 40°C to 80°C);
- the duration of the function 
- one programmed function  (only if a duration different from the default one is set).

When finished, a buzzer sounds briefly, which can be deactivated by touching any point of the display or by opening the door.

STEAM HEAT

 The function steam-heats food that has already been cooked and stored in the fridge.

1. Place the food to be heated in a container.
2. Open the door.
3. Place the container on the rack in the second shelf from the bottom.
4. Close the door.

5. Select STEAM HEAT 

6. Touch the COOKING DURATION  button or the relevant value.

7. Scroll through the values and select the required cooking duration.

8. Touch the START  button to start the reservoir filling procedure.

 The temperature of the steam heating cannot be changed by the user.

9. Proceed with reservoir filling as described above.

10. Touch the START  button to start the steam heat function.

End of steam heat

At the end, "Function ended" displays and a buzzer sounds briefly, which can be

deactivated by touching any point of the display or by opening the door.



1. Touch the HOME  button to quit the function.

12. Proceed with draining the reservoir as described above.

MELT



Ideal function for melting chocolate bars using the microwave.

1. Place the chocolate to be melted in a Pyrex or microwave-safe container.
2. Open the door.
3. Place the container on the rack in the second shelf from the bottom.
4. Close the door.

5. Select MELT 

6. Touch the COOKING DURATION  button or its value (the default value is ideal for a chocolate bar).

7. Scroll through the values and select the required cooking duration.

8. Touch the START  button to start the Melt function.



The microwave power level cannot be changed by the user.

At the end of the cooking process an acoustic signal sounds and the display shows **End**.

9. Return the function knob to the 0 position.



SOFT



Ideal function for preparing cakes and desserts using the microwave.

1. Place the food to be defrosted in a Pyrex or microwave-safe container.
2. Open the door.
3. Place the container on the rack in the second shelf from the bottom.
4. Close the door.

5. Select SOFT 

6. Touch the **COOKING DURATION**  button or its value (the default value is ideal for a piece of butter of about 250 grams or a frozen cake of about 700 grams).
7. Scroll through the values and select the required cooking duration.
8. Touch the **START**  button to start the Soft function.





The microwave power level cannot be changed by the user.

When finished, a buzzer sounds briefly, which can be deactivated by touching any point of the display or by opening the door.

POPCORN



Ideal function for preparing popcorns using the microwave.

1. Place the bag of popcorn on the glass baking tray.
2. Open the door.
3. Place the glass tray by on the rack in the second shelf from the bottom.
4. Close the door.
5. Select **POPCORNS** .
6. Touch the **COOKING DURATION**  button or the relevant value.
7. Scroll through the values and select the required cooking duration.
8. Touch the **START**  button to start the Popcorn function.



The microwave power level cannot be changed by the user.

When finished, a buzzer sounds briefly, which can be deactivated by touching any point of the display or by opening the door.

KEEP WARM



This function allows you to keep pre-cooked foods warm.

1. Select **KEEP WARM** .
2. Touch the **TEMPERATURE**  button or the relevant value.

3. Scroll through the values and select the required cooking temperature (from 60°C to 100°C).
4. Touch the **START**  button to start the Keep warm function.

When finished, a buzzer sounds briefly, which can be deactivated by touching any point of the display or by opening the door.



STONE



Useful for on stone cooking. For use with the PPR2 or STONE accessory sold separately.



Please refer to the instructions and recommendations for use described in the accessory documentation.

1. Open the door.
2. Insert the PPR2 or STONE accessory in the oven cavity (refer to the specific manual of the accessory).
3. Close the door.
4. Select **STONE** .
5. Scroll through the values and select the required cooking temperature (from 50°C to 250°C).
6. Touch the **START**  button to start the Stone function.



As with normal cooking functions, you can skip pre-heating and set a timed and programmed cooking.

7. After preheating, open the door and place the food to be cooked on the accessory.
 8. Close the door.
- When finished, a buzzer sounds briefly, which can be deactivated by touching any point of the display or by opening the door.

BBQ (Barbecue)



Useful for barbecue cooking. For use with the BBQ accessory sold separately.



Please refer to the instructions and recommendations for use described in the accessory documentation.

1. Open the door.
2. Insert the BBQ accessory into the oven cavity.

3. Close the door.
4. Select BBQ .
5. Scroll through the values and select the required cooking temperature (from 50°C to 250°C).
6. Touch the START  button to start the BBQ function.

 As with normal cooking functions, you can skip pre-heating and set a timed and programmed cooking.



7. After preheating, open the door and place the food to be cooked on the accessory.
8. Close the door.

When finished, a buzzer sounds briefly, which can be deactivated by touching any point of the display or by opening the door.

AIRFRY

 Useful to obtain fried cooking without oil. For use with the AIRFRY accessory sold separately.

 Please refer to the instructions and recommendations for use described in the accessory documentation.

1. Select AIRFRY .
2. Turn the temperature knob to select the required temperature (from 50°C to 250°C).
3. Touch the START  button to start the Airfry function.

 As with normal cooking functions, you can skip pre-heating and set a timed and programmed cooking.

4. When preheating is complete, open the door and insert the AIRFRY accessory with the food to be cooked into the oven cavity.
5. Close the door.

When finished, a buzzer sounds briefly, which can be deactivated by touching any point of the display or by opening the door.

SABBATH



 Function that allows you to cook food whilst respecting the provisions of the Jewish day of rest.

This function results in the appliance operating in a particular way:



- Cooking can proceed indefinitely, it is not possible to set any cooking duration.
- No preheating will be performed.
- The cooking temperature that can be selected ranges from 60°C to 100°C.
- Oven light disabled, any operation such as opening the door or manual activation will not activate the light.
- The internal fan remains turned off.
- Buzzers disabled.

 After activating the Sabbath mode the settings cannot be altered. Any action on the display buttons will have no effect.

1. Open the door.
2. Place the dish into the oven cavity.
3. Close the door.

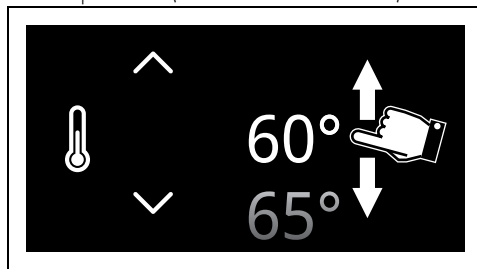
4. Select SABBATH .
5. Touch the TEMPERATURE  button or the relevant value.
6. Scroll through the values and select the temperature (from 60°C to 100°C).



7. Touch the CONFIRM  button to confirm the selected temperature.
8. Touch the START  button to start the Sabbath function.

To stop the function:

- Touch the HOME  button for around 3 seconds.

Manual reservoir filling



Function for filling water (or other liquids) into the reservoir.

1. Fill a jug supplied or a container with a sufficient amount of water for the duration of the functions that you wish to use.
2. Open the appliance door.
3. Place the jug (or container) on the open door.



The jug (or container) with the water must have a gross weight lower than 5 kg.

4. Touch the OTHER FUNCTIONS  button on the "main menu" (in the main area **2**).

5. Touch the sub-menu  button (located in the lower area **3**).

6. Touch the FILL RESERVOIR  button.

7. Remove the loading wand from its holder.
 - To remove the loading wand, press on the front of the wand until the spring contracts, then release.

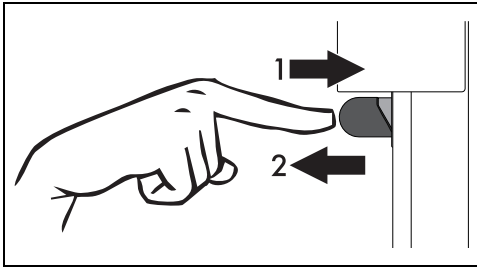

or

- Touch the WAND button  on the display (positioned in the lower area **3**).



Pay attention to the distance to be maintained so as not to be hit by the wand projection.

8. Place the end of the tube at the bottom of the jug (or container).

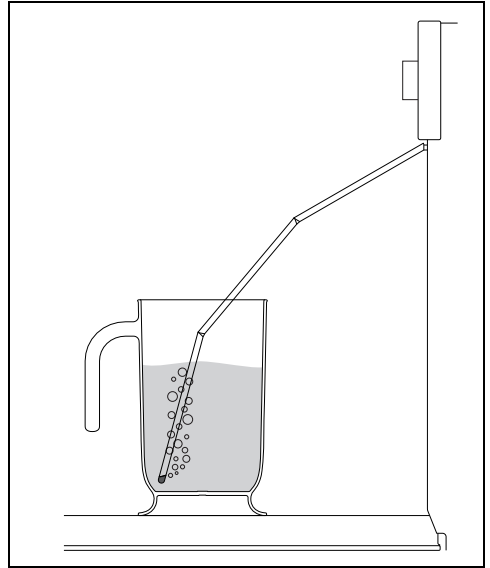

9. Press the start  button to start filling the appliance reservoir with water.
10. When finished, shake the loading wand to remove any water residue.

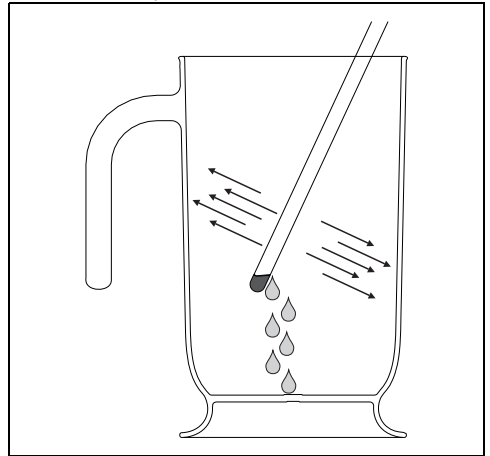

11. Place the loading wand back in its holder.
12. Remove the jug (or container).
13. Close the door.





When the door is closed, an automatic system will automatically draw in any residual water in the loading wand to avoid drips. A bubbling noise may be heard; this is completely normal.

14. Touch the CONFIRM  button to confirm that you have finished filling the reservoir.

Manual reservoir draining

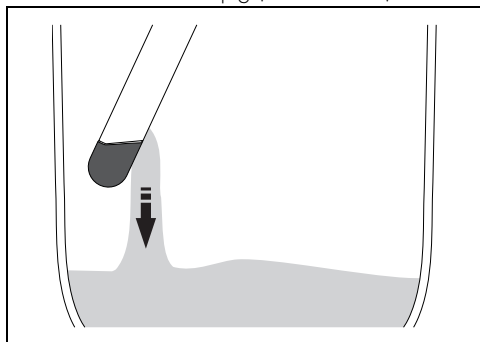

 Function for draining water (or other liquids) from the reservoir.

1. Touch the OTHER FUNCTIONS  button on the "main menu" (in the main area **2**).
2. Touch the sub-menu  button (located in the lower area **3**).
3. Touch the RESERVOIR DRAIN  button.
4. Place a jug or container on the open door.
5. Remove the loading wand from its holder.
6. Press the START  button to start draining the water into the jug (or container).



When complete, the display will indicate that the residual water removal process is complete.

7. Touch the CONFIRM  button.
8. Shake the loading wand in order to remove any remaining water.
9. Place the loading wand back in its holder.
10. Remove the jug (or container).
11. Close the door.

For the cleaning function VAPOR CLEAN  (only on some models) and the cleaning functions of the sub-menu , see the chapter CLEANING AND MAINTENANCE.

In the event of a blackout

Following a power failure during a function, the appliance automatically resumes the function it was performing, maintaining all the previous settings and discounting the time already elapsed of the function only if:

- the duration of the power failure is less than or equal to 60 seconds;
- the function does not include the use of microwaves (depending on the model);
- the pyrolytic function is in progress (depending on the model);
- the Sabbath function is in progress (regardless of power failure time).

If the power failure occurs in a condition other than those described above, the appliance remains waiting for manual consent to continue or not the function from the user for a certain time.

If the function is reactivated, the cooking settings remain as they were before the blackout, taking into account the time already elapsed.

If there is no intervention by the user, the appliance cancels the function and the display shows the current time again.



(SmegConnect models only) A notification also appears in the app when you reconnect.

Blackout during a programmed function

If the power failure occurs while a programmed cooking process is set:

- If the blackout is restored within the set start time, the appliance remains in standby mode updating the time until start.
- If the blackout is restored after the set start time, the device waits for the function to start and, if after a certain time there is no intervention by the user, the appliance cancels the function and the display shows again the current time.

Settings



In the event of a temporary power cut, all personal settings will remain stored.

The product configuration can be set using this menu.

- Touch the SETTINGS  button on the main menu (at the right in the lower area **3**).

Connection setting (SmegConnect models only)



Menu where connectivity parameters are displayed.

- In the "settings menu"  touch the CONNECTION SETTINGS  button.



For CONNECTION settings  please refer to the "Built-in Oven Connectivity" manual.

Clock settings



Menu where you can set the time and type of display.

- In the "settings menu"  touch the CLOCK SETTINGS  button.

Digital clock



Displays the current time in digital format.



In the event of a temporary power cut, the digital version will remain selected.

- Select  Digital clock.
- Select On.

Touch the CONFIRM  button to activate the Digital clock mode.



Time display



Activates/deactivates the clock display when the oven is switched off.



The "Show the time" function is factory set to Off.



If the "Show the time" function is set to On, when the appliance is in standby it displays the current time at low brightness.



When the "Show the time" function is set to On, the appliance consumes more energy than in stand-by mode.



Only for SmegConnect models: if the "Show the time" function is set to Off the connectivity switches off automatically when the clock goes into stand-by.

- Select  Show the time.
- Select On.
- Touch the CONFIRM  button to activate the time display.



Clock format



Activates/deactivates the clock display in the 12 or 24 hour format.



The Time format function is factory set to 24h.

- Select  Time format.
- Select 12h or 24h.
- Touch the CONFIRM  button to activate the required time format.

Oven settings



Dedicated menu for additional product functions.

- In the "settings menu"  touch the OVEN SETTINGS  button.

Keep warm



This mode allows the appliance to keep cooked food warm (at low temperatures) after cooking finishes with a cooking cycle for which a duration has been set (if this is not manually interrupted), without altering the taste and smell obtained during cooking.



The keep warm function will be activated 5 minutes after cooking has finished; this is indicated by a series of beeps (see cooking or function ended).



The temperature of the keep warm function is set to 80°C.

1. Select Keep warm.
2. Select On.
3. Touch the CONFIRM button to activate the Keep warm mode.

Eco light



For greater energy savings, the lights inside the oven cavity are automatically deactivated approximately one minute after the start of cooking or after the door is opened.



To stop the appliance from automatically deactivating the light after approximately one minute, set this mode to Off.



The manual on/off control is always available. Press the symbol, when available, to manually activate the oven light or the symbol to deactivate it.



The Eco light function is factory set to On.

1. Select Eco light.
2. Select On.
3. Touch the CONFIRM button to activate the Eco light mode.

Water hardness



This mode allows you to set the water hardness value in order to optimise the descaling process.



The appliance is factory set for water of medium hardness (3).

1. Select Water hardness.
2. Scroll to the desired level (from 1 a 5).
3. Touch the CONFIRM button to confirm.



If your mains water supply is too hard, we recommend using a water softener.



Request information on the hardness of your water from your local water board.

Depending on the water hardness value that has been set, after the steam functions have been used for a certain number of hours, the display will prompt you to carry out the descaling procedure.

According to the use of the appliance and the hardness degree of the water (°dH or °dF), the approximate number of hours is as follows:

Value	°dH	°dF	Hours
1	0 ÷ 11	0 ÷ 20	8
2	12 ÷ 17	21 ÷ 30	7
3	18 ÷ 24	31 ÷ 42	6
4	25 ÷ 30	43 ÷ 53	5
5	31 ÷ 50	54 ÷ 90	4

Automatic wand



Sets the automatic operation mode of the reservoir filling and draining wand.

1. Select Automatic wand .
2. Select On.
3. Touch the CONFIRM button to activate the wand automatic operation.





The Automatic wand mode is factory set to Off.

Display settings





Menu where you can change the language and modify the display settings of certain parameters.

- In the "settings menu"  touch the **DISPLAY SETTINGS**  button.

Language



Allows you to select the language of the display.

- Select  Language.
- Scroll through the available languages to select the required language.
- Touch the CONFIRM  button to confirm the language.

Controls lock



Allows the appliance to automatically lock the controls after one minute of normal operation without any intervention from the user.

- Select  Controls lock.
- Select Yes.
- Touch the CONFIRM  button to activate the Controls lock mode.



During normal operation, it is indicated by the  indicator light turning on in the information area **1**.

To temporarily disable the lock during cooking:

- Touch one of the values that you wish to modify.

A message appears on the display that indicates how to temporarily disable the Controls lock mode.

Press and hold the icon for 3 seconds
to deactivate the control lock



- Touch the  icon for 3 seconds.

Sound





Whenever one of the display symbols is pressed, the appliance beeps. This setting disables these sounds.

- Select  Sound.
- Select Off.
- Touch the CONFIRM  button to disable the sound associated with the touching of the symbols on the display.

Temperature Format





Allows you to set the temperature scale to degrees Celsius (°C) or degrees Fahrenheit (°F).

- The Temperature format function is factory set to °C.
- Select  Temperature format.
- Select °C or °F.
- Touch the CONFIRM  button to activate the required temperature format.

Display brightness



This allows the display brightness level to be selected.

- The Display brightness function is factory set to High.
- Select  Display brightness.
- Select from the options High - Medium - Low.
- Touch the CONFIRM  button to confirm the selection.

Weight type



Allows you to set the unit of measurement to display the weight value in kilograms (kg) or in ounces (oz).

- The Weight type function is factory set to kg.
- Select Weight type  kg/oz.
- Select kg or oz.

3. Touch the CONFIRM  button to activate the desired weight unit.

System info

 Menu displaying information about serial number and software versions.

- In the "settings menu"  touch the SYSTEM INFO  button.



Showrooms

 Menu dedicated to showrooms.

- Touch the SHOWROOMS  button on the "settings menu"  (at the centre of the lower area ).

Show Room (for showrooms only)

 This mode deactivates all the appliance's heating elements, while keeping the control panel active.

 During normal operation, it is indicated by the  indicator light turning on in the information area .

 To use the appliance normally, set this mode to Off.

1. Select  Show Room.
2. Select On.

CLEANING AND MAINTENANCE

Cleaning the appliance

 See General safety instructions.

Cleaning the surfaces

To keep the surfaces in good condition, they should be cleaned regularly after use. Let them cool first.

Ordinary daily cleaning

Always and only use specific products that do

3. Touch the CONFIRM  button to activate the Show Room mode.

Demo Mode (for showrooms only)

 The same as Show Room, when this mode is activated, after a certain period of inactivity, a demonstration of the various screens that illustrate the potential of the appliance is shown on the display.



 To use the appliance normally, set this mode to Off.

1. Select  Demo Mode.
2. Select On.
3. Touch the CONFIRM  button to activate the demo mode.

Restore settings

 This restores all settings to the original factory settings.

 The operation also deletes personal recipes.

- Touch the FACTORY RESET  button on the "settings menu"  (at the centre of the lower area .
1. Touch the Yes button if you want to restore the original factory operations.
or
 2. Touch the No button to cancel the operation.

not contain abrasives or chlorine-based acids. Pour the product onto a damp cloth and wipe the surface, rinse thoroughly and dry with a soft cloth or a microfibre cloth.

Food stains or residues

Do not use steel sponges and sharp scrapers as they will damage the surface.

Use normal, non-abrasive products and a wooden or plastic tool, if necessary. Rinse thoroughly and dry with a soft cloth or a microfibre cloth.

Do not allow residues of sugary foods (such as jam) to set inside the oven. If left to set for too long, they might damage the enamel lining of the oven.

Cleaning the oven cavity

In order to keep your oven in the best possible condition, clean it regularly after letting it cool down.

Avoid letting food residue dry inside the oven cavity, as this could damage the enamel.

Take out all removable parts before cleaning. For easier cleaning, it is recommended to remove:

- the door;
- The rack/tray support frames.



In the event you are using specific cleaning products, we recommend running the oven at maximum temperature for 15-20 minutes in order to eliminate any residue.

Drying

Cooking food generates moisture inside the appliance. This is a normal phenomenon and does not affect the appliance's operation in any way.

Each time you finish cooking:

1. Let the appliance cool down.
2. Remove any dirt from inside the appliance.
3. Dry the interior of the appliance with a soft cloth.
4. Leave the door open until the inside of the appliance has dried completely.

Removing rack/tray support frames

Removing the rack/tray support frames enables the sides to be cleaned more easily.



A = front housing

B = rear pin



In some models, the rear pin B can be removed and re-assembled in the same way as the front housing A.



To remove the rack/tray support frames:

1. Unscrew the front fixing pin located on the side wall near the opening of the oven cavity (you can help yourself with a tool, e.g. a coin).

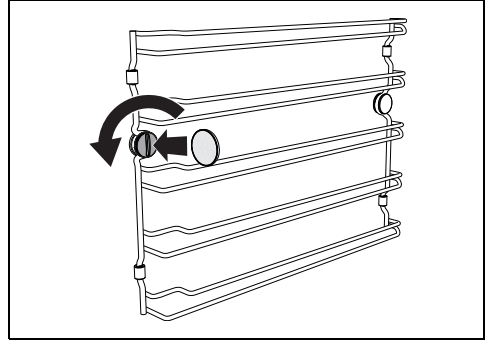

2. Carefully pull the frame towards the inside of the oven cavity to unhook it from front housing A.

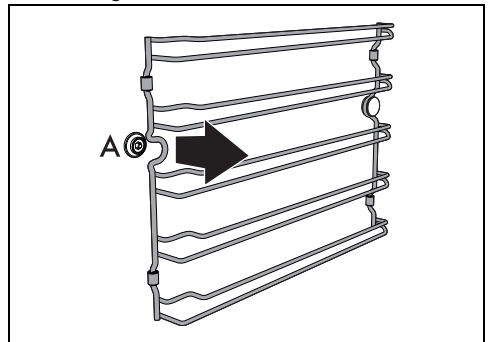

3. Remove the frame from the rear pin B located at the bottom of the side wall.

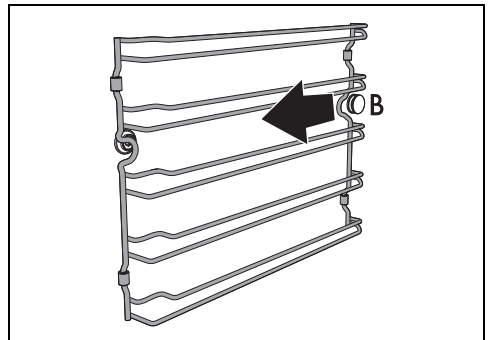

- Repeat the operation for the frame placed on the other side wall.

To refit the rack/tray support frames:

- Slide the rear part of the frame into the housing under the pin B located at the bottom of the side wall.

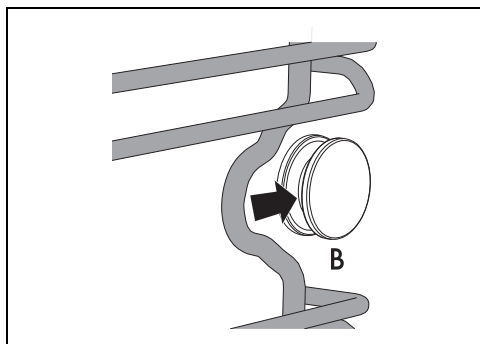

- Replace the front part of the frame in housing A on the side wall near the opening of the oven cavity.

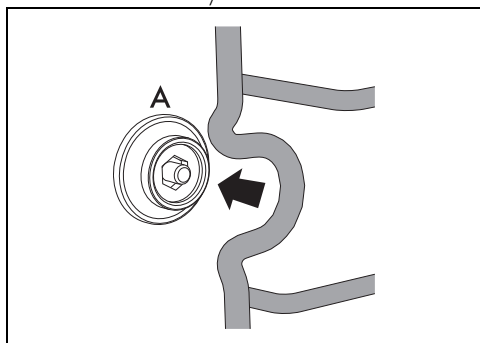

- Screw in the front fixing pin (you can help yourself with a tool, e.g. a coin).

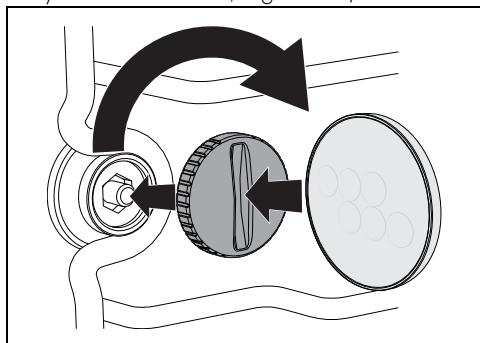

- Repeat the operation for the frame placed on the other side wall.

Vapor Clean (on some models only)



See General safety instructions.



The Vapor Clean function is an assisted cleaning procedure which facilitates the removal of dirt. Thanks to this process, it is possible to clean the inside of the oven very easily. The dirt residues are softened by the heat and water vapour for easier removal afterwards.

Preliminary operations

Before starting the Vapor Clean function:

- Completely remove all accessories from inside the oven.
- If present, remove the temperature probe.
- If present, remove the self-cleaning panels.
- Close the door.
- During the assisted cleaning cycle, wash the self-cleaning panels (where fitted), which were previously removed, separately in warm water and a small amount of detergent.





Vapor Clean cycle setting



If the internal temperature is higher than expected, the function is not activated. Let the appliance cool down before activating the function.



The duration and temperature of the Vapor Clean function cannot be changed by the user.

- Touch the OTHER FUNCTIONS  button on the "main menu" (in the main area ).
- Select VAPOR CLEAN .
- Touch the START  button to start the reservoir filling procedure.
- Proceed with reservoir filling as described above.

Vapor Clean cleaning phase

- Touch the START  button to start the Vapor Clean function.

This stage is indicated by a progressive increase in the cooking level.



End of Vapor Clean

At the end of the Vapor Clean function, "Function ended" displays and a buzzer sounds briefly, which can be deactivated by touching any point of the display or by opening the door.



1. Touch the HOME  button to quit the function.
2. Proceed with draining the reservoir as described above.
3. Open the door and wipe away the less stubborn dirt with a microfibre cloth.
4. Use a non-scratch sponge with brass filaments on tougher encrustations.
5. In case of grease residues use specific oven cleaning products.
6. Remove any remaining water from the oven cavity.
7. Where fitted, reposition the self-cleaning panels and the rack/tray support frames.

For greater hygiene and to avoid foods taking on unpleasant odours:

- We recommend drying the inside of the oven with a fan assisted function at 160°C for around 10 minutes.
- Where the self-cleaning panels are fitted, we recommend drying the inside of the oven with a simultaneous catalysis cycle.



We recommend wearing rubber gloves for these operations.



For easier manual cleaning of parts that are difficult to reach, we recommend removing the door.

Descaling



The presence of scale due to lack of descaling can compromise correct operation of the appliance in the long term.



Descaling is a long process (more than one hour) that requires the user to be present in front of the appliance.

Periodically the display will prompt you to perform the boiler descaling procedure.

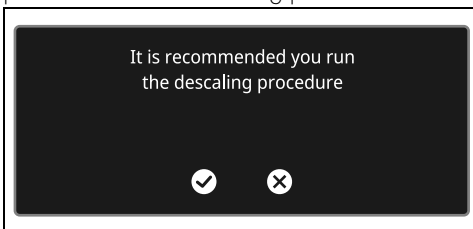

1. Touch the CONFIRM  button to confirm.

The appliance suggests the Drain reservoir function.



We recommend performing descaling every time this is indicated on the display in order to keep the boiler in perfect operating condition.



The descaling process can be skipped 2 consecutive times.

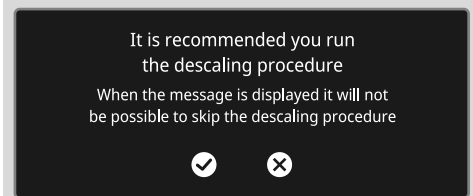

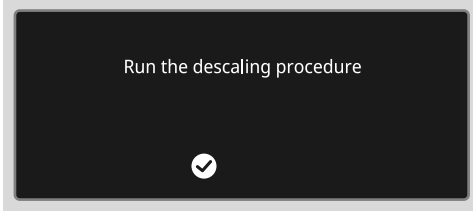

After this, the appliance will not allow you to run any other function until the descaling process is performed.



Preliminary operations

In case there is residual water inside the reservoir:

1. Open the door.
2. Place a jug or a container on the open door.
3. Pull the loading nozzle out of its housing.
4. Press the START  button to start draining the water into the jug (or container).
Residual water begins to drain into the jug (or container).
5. Wait for the end of the drain flow.
6. Empty the water in the jug (or container).
7. Touch the CONFIRM  button to continue the function.

 From now on, it will no longer be possible to cancel the descaling process.

Reservoir filling

1. Mix 100 g of citric acid with 650 ml of water in a jug.

 Do not use lactic acid or other descaling agents.

2. Pull the loading nozzle out of its housing.
3. Place the end of the tube at the bottom of the jug (or container).
4. Touch the START  button to start filling the reservoir of the appliance with the descaling solution.
5. In the end, shake the loading nozzle to remove any remaining water.
6. Place the loading nozzle place in its housing.
7. Remove the jug (or container).

Boiler descaling function

1. Close the door
2. Descaling starts.

At the end of the descaling process the display shows the request to drain the water softener.

Reservoir draining

1. Open the door
2. Place a jug or a container on the open door.
3. Pull the loading nozzle out of its housing.
4. Press the START  button to start draining the water softener into the jug (or container).

The descaling solution begins to flow into the jug.

5. Wait for the end of the drain flow.
6. Empty the descaling solution in the jug (or container).



Take care: the descaling solution may be still hot.

Cleaning the reservoir and hydraulic circuit

Once the water softener has been drained, the appliance starts the cleaning procedure for the reservoir and the hydraulic circuit.



Use cold tap water which is not too hard, softened water or still mineral water.





Do not use distilled water, tap water with a high chloride content (> 40 mg/l), or other liquids.

The display will show the request to fill the reservoir with water.

1. Fill a jug or container with about 2 litres of clean water.
2. Open the oven door.
3. Place the jug (or container) on the open door.



The overflowing of water inside the oven cavity is not intended as a malfunction, rather it is part of the rinsing procedure.

4. Pull the loading nozzle out of its housing.
5. Place the end of the tube at the bottom of the jug (or container).
6. Press the START  button to start filling the appliance reservoir with water.
7. When you have finished filling water into the reservoir, touch the CONFIRM button  to continue with the function.

The appliance starts the function using the parameters set.

- When cleaning the tank and the hydraulic circuit, leave the jug on the door open with the filling nozzle inside. The appliance cyclically discharges certain quantities of water used for cleaning.
- During this process, the overflowing of water inside the oven cavity is not intended as a malfunction, rather it is part of the rinsing

procedure.

- At the end of the cleaning process, the display indicates the request to drain water.
- Clean and dry any residual water inside the oven cavity.
- Open the door
- Place a jug or a container on the open door.
- Pull the loading nozzle out of its housing.
- Press the **START**  button to start draining the water into the jug (or container).
- Wait for the end of the drain flow.



When complete, the display will indicate that the residual water removal process is complete.

Manual descaling



Function that performs descaling of boiler.



When you wish to perform descaling in advance, you can run the function manually:

- Touch the **OTHER FUNCTIONS**  button on the "main menu" (in the main area **2**).
- Touch the sub-menu  button (located in the lower area **3**).
- Touch the **DESCALING** button .
- Proceed with descaling as described in the previous paragraphs.

Cleaning the reservoir and the water circuit manually



This function allows you to clean the reservoir and the water circuit of the appliance.

- Touch the **OTHER FUNCTIONS**  button on the "main menu" (in the main area **2**).
- Touch the sub-menu  button (located in the lower area **3**).
- Touch the **CLEAN RESERVOIR**  button.

Preliminary operations

- Fill a jug or a container with approx. 2 litres of water.
- Open the appliance door.
- Place the jug (or container) on the open door.



The jug (or container) with the water must have a gross weight lower than 5 kg.

- Remove the loading wand from its holder.
 - To remove the loading wand, press on the front of the wand until the spring contracts, then release.

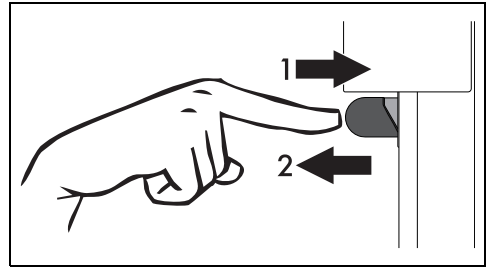

- Touch the **WAND** button  on the display (positioned in the lower area **3**).



Pay attention to the distance to be maintained so as not to be hit by the wand projection.

- Place the end of the tube at the bottom of the jug (or container).

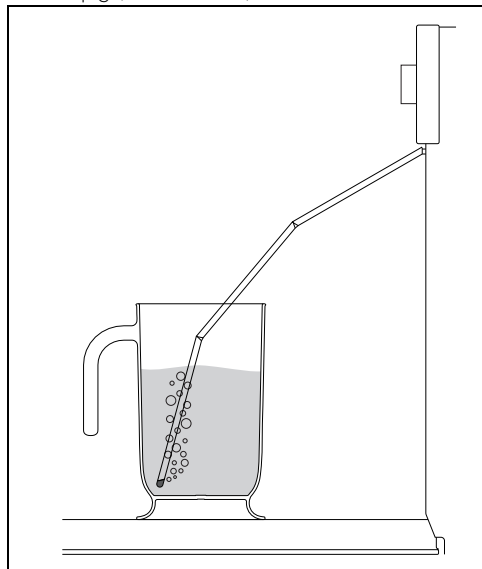

- Press the start  button to start filling the appliance reservoir with water.
- Touch the CONFIRM  button to confirm that you have finished filling the reservoir.

The appliance starts the function using the parameters set.

Cleaning the water circuit

- When cleaning the reservoir and the hydraulic circuit, leave the jug on the door open with the loading wand inside. The appliance cyclically discharges certain quantities of water used for cleaning.
- During this process, the overflowing of water inside the oven cavity is not intended as a malfunction, rather it is part of the rinsing procedure.

End of water circuit cleaning

- After completion of the cleaning process the request to drain the water is shown on the display.
- Clean and dry any residual water inside the oven cavity.

Reservoir draining

- Open the door
- Place a jug or container on the open door.
- Remove the loading wand from its holder.

- Press the START  button to start draining the water into the jug (or container).

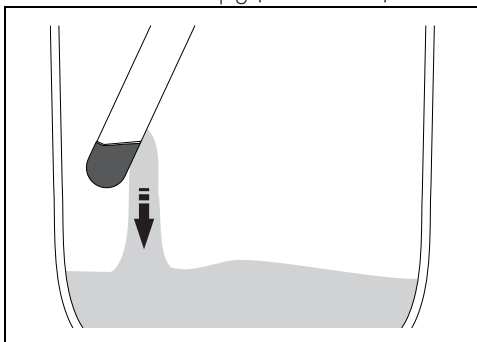

- Wait for the end of the drain flow. When complete, the display will indicate that the residual water removal process is complete.



It is recommended to carry out the cleaning process of the reservoir and the water circuit a couple of times.





You can also use a cleaning solution instead of water. In this case it is advisable to carry out at least a couple of water rinses afterwards, following the instructions in this chapter.

- Touch the CONFIRM  button.
- Shake the loading wand in order to remove any remaining water.
- Place the loading wand back in its holder.
- Remove the jug (or container).
- Drain the water from the jug.
- Close the door.

Sanitization

Sanitization with steam allows to remove the last residues of descaling from the hydraulic circuit.

- set a 70% combined steam function lasting at least half an hour.
- Fill the jug with clean water.
- Open the appliance door.
- Rest the jug on the open door.
- Remove the loading wand from its holder.
- Place the end of the tube at the bottom of the jug (or container).
- Press the start  button to start filling the appliance reservoir with water.
- When finished, shake the loading wand to remove any water residue.

9. Place the loading wand back in its holder.
10. Remove the jug (or container).
11. Close the door.
12. Touch the START  button to start the selected steam function.
13. Wait for the function to be executed until the end.
14. At the end of the function, drain the reservoir as described above.
15. Wait for the end of the drain flow.
16. Drain the water from the jug.

 Take care: wait for the oven cavity to cool down.







17. Open the door.
18. Wipe off any spillage of water in the oven cavity with a cloth or sponge.
19. Close the door.

Reservoir calibration

 This function allows you to calibrate the correct reading of the quantity of water (or other liquid) inside the reservoir.



Over time, the quantities of water in the reservoir may not be read correctly by the appliance sensor. In this case, the functionality of the appliance sensor can be restored to an optimal condition.

Preliminary operations

1. Touch the OTHER FUNCTIONS  button on the "main menu" (in the main area ).
2. Touch the sub-menu  button (located in the lower area ).
3. Touch the RESERVOIR CALIBRATION button  (positioned in the lower area ).

Empty reservoir calibration



1. Open the appliance door.
2. Place an empty jug on the open door.

3. Touch the WAND button  on the display (positioned in the lower area ).

 Pay attention to the distance to be maintained so as not to be hit by the wand projection.

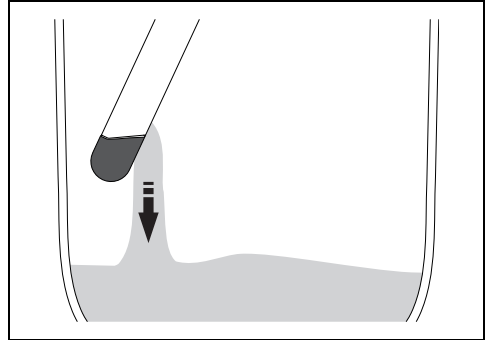
4. Pull out the wand and dip the end into the bottom of the empty jug.
5. Press the START  button to start draining the water left in the jug.



6. Wait for the end of the drain flow.
7. Make sure that no more water comes out of the wand, then touch the STOP button .
8. Then touch the EMPTY RESERVOIR CALIBRATION button  to continue calibration.

Full reservoir calibration



1. Fill a jug with exactly 1 litre of water.

 We recommend using a digital kitchen scale and measuring 1000 grams of water.

2. Place the jug with 1 litre of water on the open door.

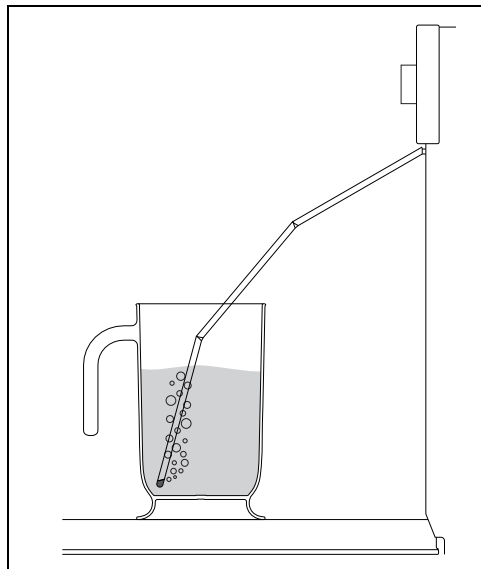
- Immerse the end of it into the jug until it reaches the bottom.



- Press the **START**  button to start filling the appliance reservoir with water.
- Wait for the end of the reservoir filling.
- Make sure that the appliance has sucked up all the water contained in the jug, then touch the **STOP** button .
- Place the loading wand back in its holder.
- Remove the jug.

- Close the door.



When the door is closed, an automatic system will automatically draw in any residual water in the loading wand to avoid drips. A bubbling noise may be heard; this is completely normal.

- Touch the **FULL RESERVOIR CALIBRATION** button  to complete calibration.

- Wait for the end of calibration.

On completion, a warning on the display indicates the end of the calibration procedure.

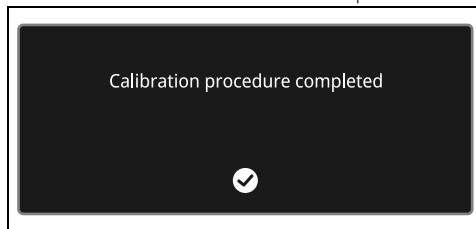

- Touch the **CONFIRM**  button to end the reservoir calibration procedure.

The display suggests to drain the water from the reservoir. You can either use the water for steam cooking or proceed as described in the chapter for Reservoir draining.

Extraordinary maintenance

Seal maintenance tips

The seal should be soft and elastic.

- To keep the seal clean, use a non-abrasive sponge and wash with lukewarm water.

INSTALLATION

Electrical connection



See General safety instructions.

General information

Check the mains characteristics against the data indicated on the plate.

The identification plate bearing the technical data, serial number and brand name is visibly positioned on the appliance.

Do not remove this plate for any reason.

The appliance must be connected to ground using a wire that is at least 20 mm longer than the other wires.

The appliance can work in the following modes:

- 220-240 V \sim**

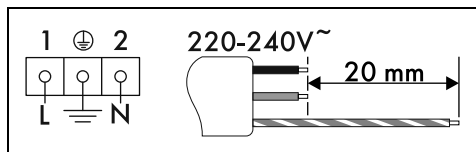

3 x 1.5 mm² three-core cable.



The values indicated above refer to the cross section of the internal lead.



The aforementioned power cables are sized taking into account the coincidence factor (in compliance with standard EN 60335-2-6).

Positioning



See General safety instructions.

Position of the power cable

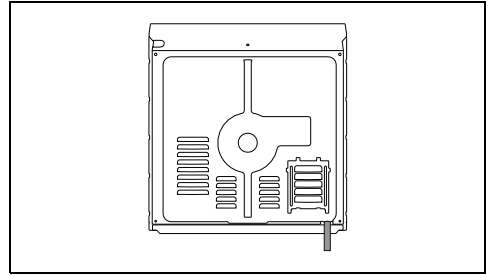

Front panel seal

Glue the supplied seal to the rear part of the front panel to avoid water or other liquids from leaking in.

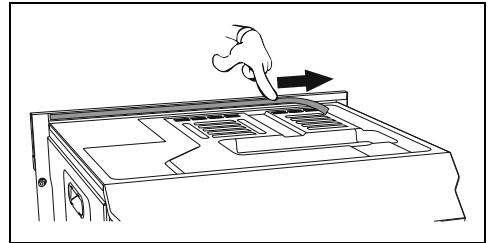

Fastening bushings

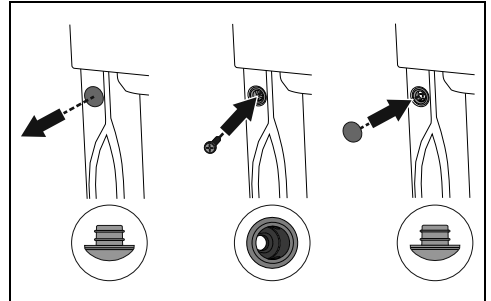

1. Remove the bushing covers on the front of the appliance.
2. Mount the appliance into the recess.
3. Secure the appliance to the cabinet using screws.
4. Cover the bushings with the previously removed covers.

Fixed connection

Fit the power line with an all-pole circuit breaker with a contact separation distance sufficient to provide complete disconnection in category III overvoltage conditions, pursuant to installation regulations.

For the Australian/New Zealand market:

The circuit breaker incorporated in the fixed connection must comply with AS/NZS 3000.

Connection with plug and socket

Make sure that the plug and socket are of the same type.

Avoid using adapters, gang sockets or shunts as these could cause overheating and a risk of burns.

Cable replacement



Power voltage
Danger of electrocution

- Disconnect the mains power supply.

1. Unscrew the rear casing screws and remove the casing to access the terminal board.

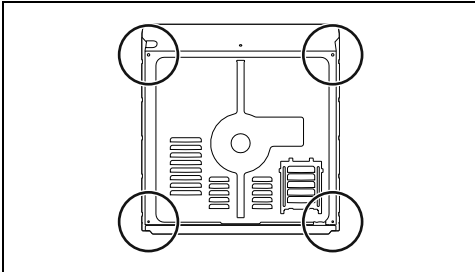

2. Replace the cable.
3. Make sure that the cables (for the oven or any hob) follow the best route in order to avoid any contact with the appliance.

Appliance overall dimensions (mm)

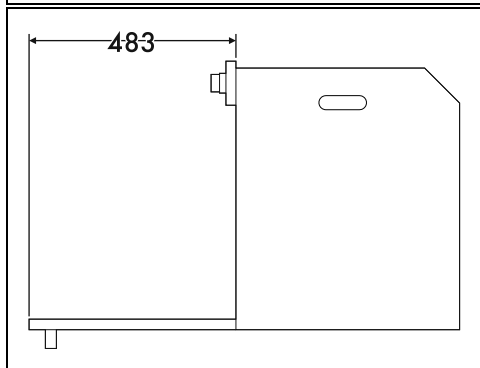
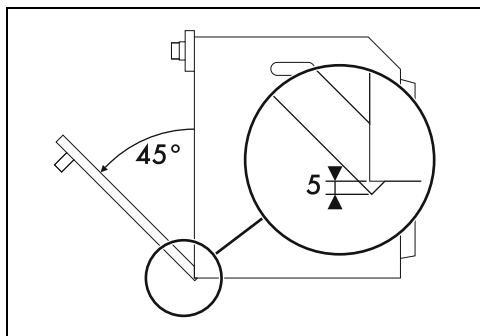
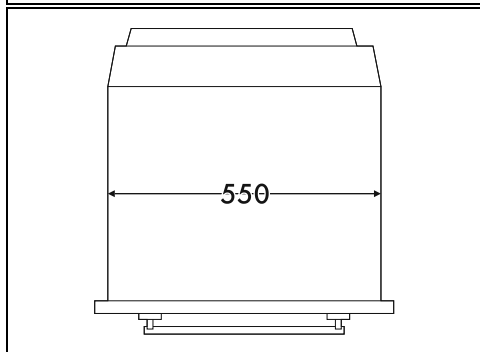
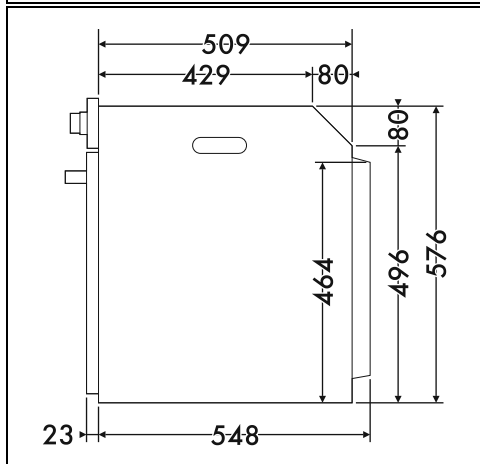
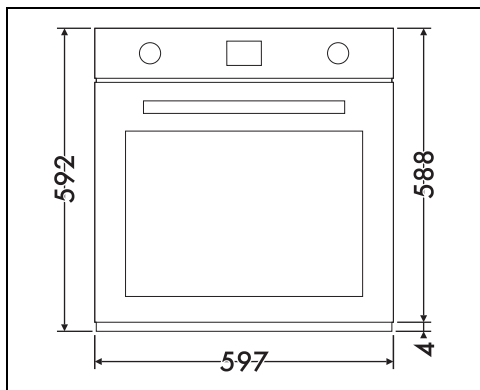

EN

Mounting into a column (mm)

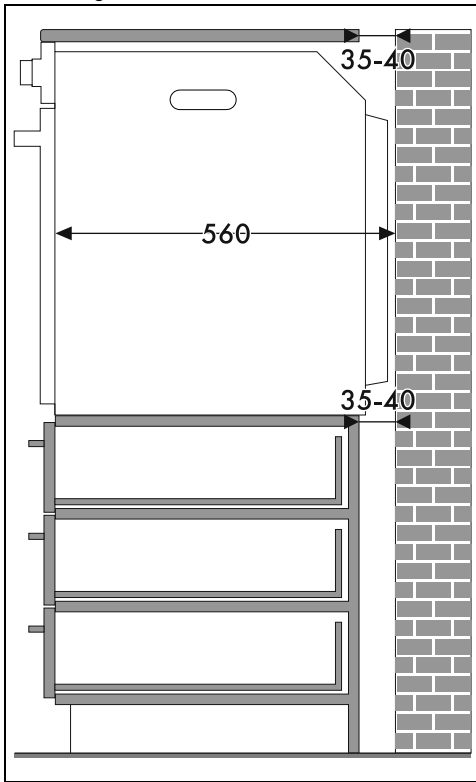

* Make sure that the cabinet top/rear section has an opening approx. 35-40 mm deep.

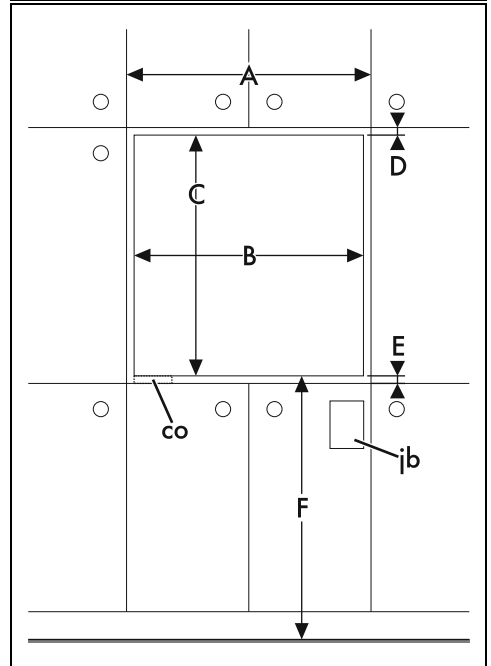
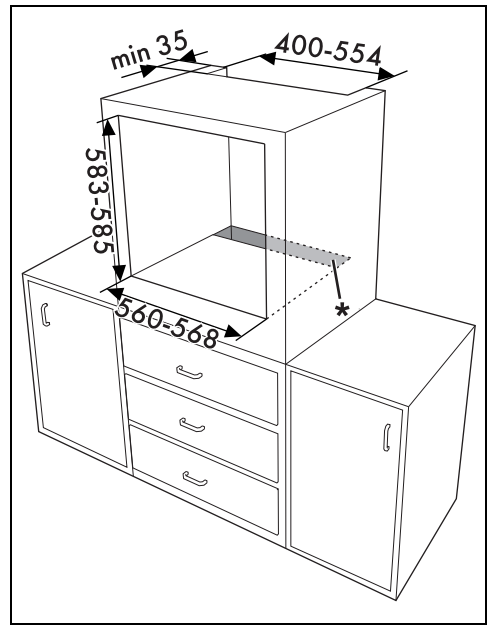

Mounting under worktops (mm)

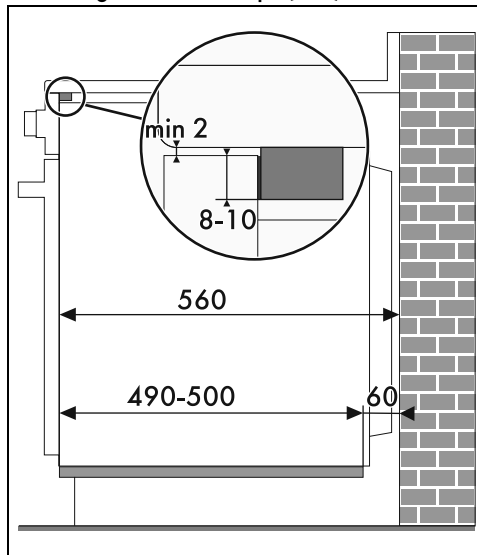
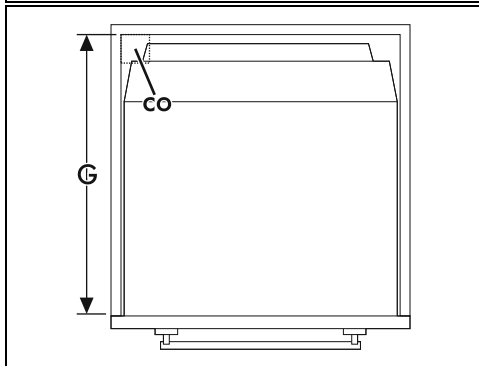
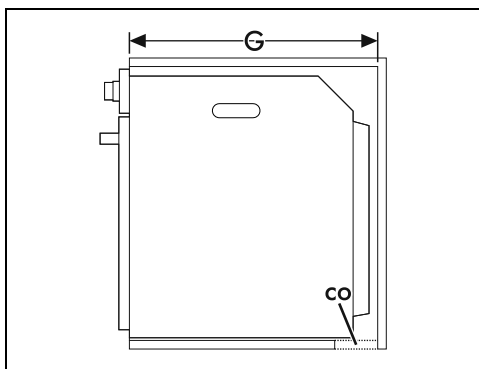

If the appliance is to be built-in under a worktop, a wooden bar has to be installed order to use the seal that is glued to the back of the front panel to prevent water or other liquids leaking in.

A min. 603 mm

B 560 - 568 mm

C 583 - 585 mm

D 9 - 11 mm

E min. 5 mm

F 121 - 1105 mm

G min. 560 mm

H min. 594 mm

co Cutout for power cord (min. 6 cm²)

jb Electrical connection box

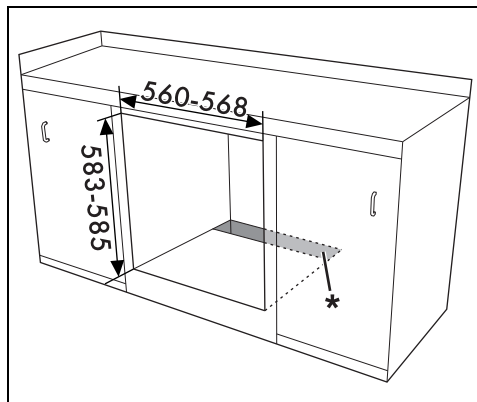

* Make sure that the piece of furniture top/rear part has an opening approx. 60 mm deep.

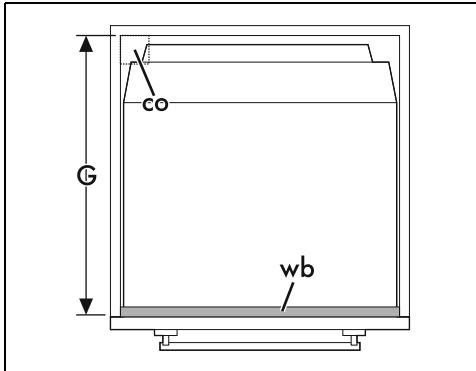
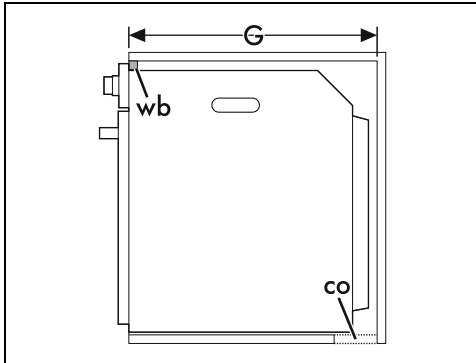
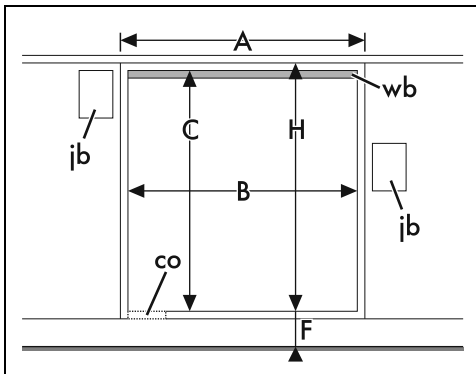

A min. 603 mm

B 560 - 568 mm

C 583 - 585 mm

D 9 - 11 mm

E min. 5 mm

F 121 - 1105 mm

G min. 560 mm

H min. 594 mm

co Cutout for power cord (min. 6 cm²)

ib Electrical connection box

wb Wooden bar (recommended)